

3 POINT HITCH WOOD CHIPPER MODELS BX42/R, BX62S/R & BX92S/R

OPERATOR'S MANUAL



1 INTRODUCTION

Congratulations on your choice of a 3 Point Hitch Wood Chipper to compliment your operation. This equipment has been designed and manufactured to meet the needs of a discerning timber or landscaping industry.

Safe, efficient and trouble free operation of your Wood Chipper requires that you and anyone else who will be using or maintaining the chipper, read and understand the Safety, Operation, Maintenance Trouble Shooting information contained within the Operator's Manual.



BX32



BX42/4 OS Hopper

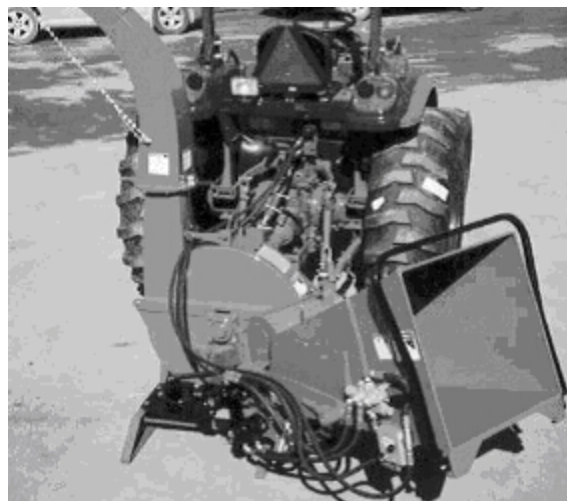

BX62/620R Hopper

This manual covers the 3 Point Hitch Wood Chipper, BX42S/R, BX62S/R and BX92S/R. Use the Table of Contents or Index as a guide to locate required information.

Keep this manual handy for frequent reference and to pass on to new operators or owners.

OPERATOR ORIENTATION - The directions left, right, front and rear, as mentioned throughout this manual, are determined when sitting in the tractor driver's seat and facing in the direction of travel.

2 SAFETY

SAFETY ALERT SYMBOL

This Safety Alert symbol means
ATTENTION! BECOME ALERT!
YOUR SAFETY IS INVOLVED!

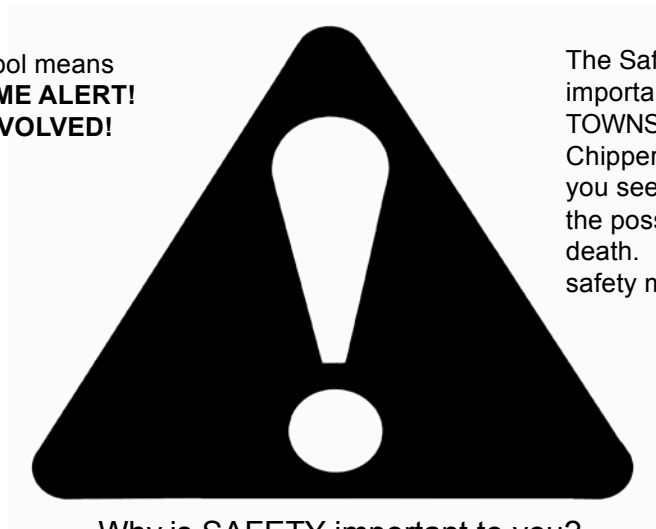

The Safety Alert symbol identifies important safety messages on the TOWNSUNNY 3 Point Hitch Wood Chipper and in the manual. When you see this symbol, be alert to the possibility of personal injury or death. Follow the instructions in the safety message.

Why is SAFETY important to you?

3 Big Reasons

Accidents Disable and Kill
Accidents Cost
Accidents Can Be Avoided

SIGNAL WORDS:

Note the use of the signal words **DANGER**, **WARNING** and **CAUTION** with the safety messages. The appropriate signal word for each message has been selected using the following guide-lines:

DANGER - Indicates an imminently hazardous situation that, if not avoided, will result in death or serious injury. This signal word is to be limited to the most extreme situations typically for machine components which, for functional purposes, cannot be guarded.

WARNING - Indicates a potentially hazardous situation that, if not avoided, could result in death or serious injury, and includes hazards that are exposed when guards are removed. It may also be used to alert against unsafe practices.

CAUTION - Indicates a potentially hazardous situation that, if not avoided, may result in minor or moderate injury. It may also be used to alert against unsafe practices.

SAFETY

YOU are responsible for the SAFE operation and maintenance of your 3 Point Hitch Wood Chipper. **YOU** must ensure that you and anyone else who is going to use, maintain or work around the 3 Point Hitch Wood Chipper be familiar with the using and maintenance procedures and related **SAFETY** information contained in this manual. This manual will take you step-by-step through your working day and alerts you to all good safety practices that should be used while using the 3 Point Hitch Wood Chipper.

Remember, **YOU** are the key to safety. Good safety practices not only protect you but also the people around you. Make these practices a working part of your safety program. Be certain that **EVERYONE** using this equipment is familiar with the recommended using and maintenance procedures and follows all the safety precautions. Most accidents can be prevented. Do not risk injury or death by ignoring good safety practices.

- 3 Point Hitch Wood Chipper owners must give operating instructions to operators or employees before allowing them to operate the machine, and at least annually thereafter.
- The most important safety device on this equipment is a SAFE operator. It is the operator's responsibility to read and understand ALL Safety and Operating instructions in the manual and to follow these. Most accidents can be avoided.
- A person who has not read and understood all using and safety instructions is not qualified to use the machine. An untrained operator exposes himself and bystanders to possible serious injury or death.
- Do not modify the equipment in any way. Unauthorized modification may impair the function and/or safety and could affect the life of the equipment.
- Think SAFETY! Work SAFELY!

2.1 GENERAL SAFETY

1. Read and understand the Operator's Manual and all safety signs before using, maintaining, adjusting or cleaning the 3 Point Hitch Wood Chipper.



2. Have a first-aid kit available for use should the need arise and know how to use it.

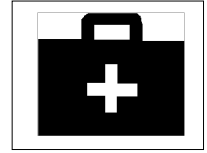

3. Have a fire extinguisher available for use should the need arise and know how to use it.

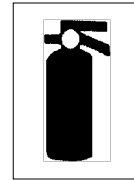

4. Do not allow riders.

5. Wear appropriate protective gear. This list includes but is not limited to:

- A hard hat
- Protective shoes with slip resistant soles
- Protective glasses, goggles or face shield
- Heavy gloves
- Wet weather gear
- Hearing Protection
- Respirator or filter mask



6. Install and secure all guards before starting.

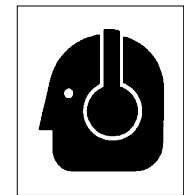

7. Wear suitable ear protection for prolonged exposure to excessive noise.

8. Turn machine off, stop and disable engine, remove ignition key and place in your pocket, set park brake and wait for all moving parts to stop before servicing, adjusting, repairing or unplugging.

9. Clear the area of people, especially small children, before using the unit.

10. Review safety related items annually with all personnel who will operating or maintaining the 3 Point Hitch Wood Chipper.

2.2 EQUIPMENT SAFETY GUIDELINES

1. Safety of the operator and bystanders is one of the main concerns in designing and developing equipment. However, every year many accidents occur which could have been avoided by a few seconds of thought and a more careful approach to handling equipment. You, the operator, can avoid many accidents by observing the following precautions in this section. To avoid personal injury or death, study the following precautions and insist those working with you, or for you to follow them.
2. In order to provide a better view, certain photographs or illustrations in this manual may show an assembly with a safety shield removed. However, equipment should never be used in this condition. Keep all shields in place. If shield removal becomes necessary for repairs, replace the shield prior to use.
3. Replace any safety sign or instruction sign that is not readable or is missing. Location of such safety signs is indicated in this manual.
4. Never use alcoholic beverages or drugs which can hinder alertness or coordination while using this equipment. Consult your doctor about using this machine while taking prescription medications.
5. **Under no circumstances should young children be allowed to work with this equipment. Do not allow persons to use or assemble this unit until they have read this manual and have developed a thorough understanding of the safety precautions and of how it works.** Review the safety instructions with all users annually.
6. This equipment is dangerous to children and persons unfamiliar with its operation. The operator should be a responsible, properly trained and physically able person familiar with machinery and trained in this equipment's operations. If the elderly are assisting with work, their physical limitations need to be recognized and accommodated.
7. Never exceed the limits of a piece of machinery. If its ability to do a job, or to do so safely, is in question - **DON'T TRY IT.**
8. Do not modify the equipment in any way. Unauthorized modification may result in serious injury or death and may impair the function and life of the equipment.
9. In addition to the design and configuration of this implement, including Safety Signs and Safety Equipment, hazard control and accident prevention are dependent upon the awareness, concern, prudence, and proper training of personnel involved in the operation, transport, maintenance, and storage of the machine. Refer also to Safety Messages and operation instruction in each of the appropriate sections of the tractor and machine manuals. Pay close attention to the Safety Signs affixed to the tractor and the machine.

2.3 SAFETY TRAINING

1. Safety is a primary concern in the design and manufacture of our products. Unfortunately, our efforts to provide safe equipment can be wiped out by a single careless act of an operator or bystander.
2. In addition to the design and configuration of equipment, hazard control and accident prevention are dependent upon the awareness, concern, prudence and proper training of personnel involved in the operation, transport, maintenance and storage of this equipment.

3. It has been said, "The best safety feature is an informed, careful operator." We ask you to be that kind of an operator. It is the operator's responsibility to read and understand ALL Safety and Using instructions in the manual and to follow these. Accidents can be avoided.

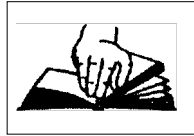

4. **Working with unfamiliar equipment can lead to careless injuries. Read this manual before assembly or using, to acquaint yourself with the machine. If this machine is used by any person other than yourself, or is loaned or rented, it is the machine owner's responsibility to make certain that the operator, prior to using:**
 - a. **Reads and understands the operator's manuals.**
 - b. **Is instructed in safe and proper use.**
5. Know your controls and how to stop tractor and machine quickly in an emergency. Read this manual and the one provided with tractor.
6. Train all new personnel and review instructions frequently with existing workers. Be certain only a properly trained and physically able person will use the machinery. A person who has not read and understood all using and safety instructions is not qualified to use the machine. An untrained operator exposes himself and bystanders to possible serious injury or death. If the elderly are assisting with the work, their physical limitations need to be recognized and accommodated.

2.4 SAFETY SIGNS

1. Keep safety signs clean and legible at all times.
2. Replace safety signs that are missing or have become illegible.
3. Replaced parts that displayed a safety sign should also display the current sign.
4. Safety signs displayed in Section 3 each have a part number in the lower right hand corner. Use this part number when ordering replacement parts.
5. Safety signs are available from your authorized Distributor or Dealer Parts Department or the factory.

How to Install Safety Signs:

- Be sure that the installation area is clean and dry.
- Be sure temperature is above 50°F (10°C).
- Determine exact position before you remove the backing paper.
- Remove the smallest portion of the split backing paper.
- Align the sign over the specified area and carefully press the small portion with the exposed sticky backing in place.
- Slowly peel back the remaining paper and carefully smooth the remaining portion of the sign in place.
- Small air pockets can be pierced with a pin and smoothed out using the piece of sign backing paper.

2.5 PREPARATION

1. Never use the machine until you have read and completely understand this manual, the tractor Operator's Manual and each of the Safety Messages found on the safety signs on the tractor and machine.

2. Personal protection equipment including hard hat, safety glasses, safety shoes, and gloves are recommended during assembly, installation, operation, adjustment, maintaining, repairing, removal, cleaning, or moving the unit. Do not allow long hair, loose fitting clothing or jewelry to be around equipment.

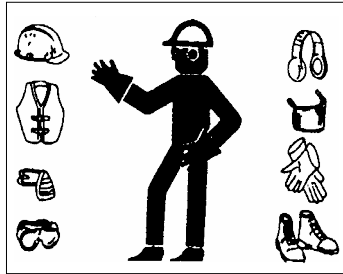

3. **PROLONGED EXPOSURE TO LOUD NOISE MAY CAUSE PERMANENT HEARING LOSS!**

Power equipment with or without equipment attached can often be noisy enough to cause permanent, partial hearing loss. We recommend that you wear hearing protection on a full-time basis if the noise in the Operator's position exceeds 80db. Noise over 85db on a long-term basis can cause severe hearing loss. Noise over 90db adjacent to the Operator over a long-term basis may cause permanent, total hearing loss. **NOTE:** Hearing loss from loud noise (from tractors, chain saws, radios, and other such sources close to the ear) is cumulative over a lifetime without hope of natural recovery.

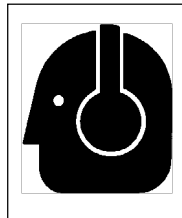

4. Clear working area of stones, branches or hidden obstacles that might be hooked or snagged, causing injury or damage.
5. Use only in daylight or good artificial light.
6. Be sure machine is properly mounted, adjusted and in good operating condition.
7. Ensure that all safety shielding and safety signs are properly installed and in good condition.

2.6 MAINTENANCE SAFETY

1. Good maintenance is your responsibility. Poor maintenance is an invitation to trouble.
2. Follow good shop practices.

- Keep service area clean and dry.
- Be sure electrical outlets and tools are properly grounded.
- Use adequate light for the job at hand.



3. Make sure there is plenty of ventilation. Never operate the engine of the towing vehicle in a closed building. The exhaust fumes may cause asphyxiation.
4. Before working on this machine, shut off the engine, set the brake, and turn fuel valve off.
5. Never work under equipment unless it is blocked securely.
6. Always use personal protection devices such as eye, hand and hearing protectors, when performing any service or maintenance work. Use heavy or leather gloves when handling blades.
7. Where replacement parts are necessary for periodic maintenance and servicing, genuine factory replacement parts must be used to restore your equipment to original specifications. The manufacturer will not be responsible for injuries or damages caused by use of unapproved parts and/or accessories.
8. A fire extinguisher and first aid kit should be kept readily accessible while performing maintenance on this equipment.

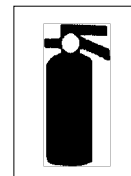
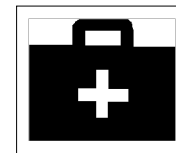

2.7 OPERATING SAFETY

1. Please remember it is important that you read and heed the safety signs on the 3 Point Hitch Wood Chipper. Clean or replace all safety signs if they cannot be clearly read and understood. They are there for your safety, as well as the safety of others. The safe use of this machine is strictly up to you, the operator.
2. All things with moving parts are potentially hazardous. There is no substitute for a cautious, safe-minded operator who recognizes potential hazards and follows reasonable safety practices. The manufacturer has designed this 3 Point Hitch Wood Chipper to be used with all its safety equipment properly attached, to minimize the chance of accidents. Study this manual to make sure you have all safety equipment attached.
3. Close and secure rotor cover before operating.
4. Close and secure all guards, deflectors and shields before starting and operating.
5. Read and understand operator's manual before starting. Review safety instructions annually.
6. Personal protection equipment including hearing protection, hard hat, safety glasses, safety shoes, and gloves are recommended during assembly, installation, operation, adjustment, maintaining, repairing, removal, or moving. Do not allow long hair, loose-fitting clothing, or Jewelry to be around moving parts.
7. Keep hydraulic lines and fittings tight, in good condition and free of leaks.
8. Never place any part of your body where it would be in danger if movement should occur during assembly, installation, operation, maintenance, repairing, unplugging or moving.
9. Turn machine off, stop and disable engine, remove ignition key and place in your pocket, set park brake and wait for all moving parts to stop before servicing, adjusting, repairing or unplugging.
10. Do not run machine inside a closed building to prevent asphyxiation from engine exhaust.
11. Use care when feeding material into chipper. Do not send metal, bottles, cans, rocks, glass or other foreign material into wood chipper. If foreign material enters chipper, stop machine, turn engine off and place ignition key in your pocket and wait for all moving parts to stop before removing material and/or unplugging. Inspect machine for damaged or loose parts before resuming work.
12. Never use alcoholic beverages or drugs which can hinder alertness or coordination while operating this equipment. Consult your doctor about operating this machine while taking prescription medications.
13. Do not allow riders on this machine at any time. There is no safe place for any riders.
14. Never allow children or unauthorized people to operate or be around this machine.
15. Do not reach into rotor or feed hopper openings when the engine is running. Install and secure access covers before starting engine.
16. Keep the working area clean and free of debris to prevent tripping. Operate only on level ground.
17. Do not point discharge at people, animals or buildings. Rotor can expel wood chips fast enough to cause injury.
18. Do not move or transport chipper when the rotor is turning.
19. Do not exceed a safe travel speed when transporting.

2.8 HYDRAULIC SAFETY

1. Make sure that all the components in the hydraulic system are kept in good condition and are clean.
2. Before applying pressure to the system, make sure all components are tight, and that lines, hoses and couplings are not damaged.
3. Do not attempt any makeshift repairs to the hydraulic lines, fittings or hoses by using tapes, clamps or cements. The hydraulic system operates under extremely high pressure. Such repairs will fail suddenly and create a hazardous and unsafe condition.
4. Wear proper hand and eye protection when searching for a high pressure hydraulic leak. Use a piece of wood or cardboard as a backstop instead of hands to isolate and identify a leak.
5. If injured by a concentrated high-pressure stream of hydraulic fluid, seek medical attention immediately. Serious infection or toxic reaction can develop from hydraulic fluid piercing the skin surface.
6. Relieve pressure on hydraulic system before maintaining or working on system.

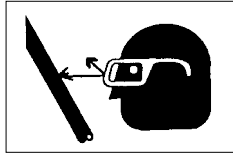

2.10 TRANSPORT SAFETY

1. Comply with state and local laws governing safety and transporting of machinery on public roads.
2. Check that all the lights, reflectors and other lighting requirements are installed and in good working condition.
3. Do not exceed a safe travel speed. Slow down for rough terrain and cornering.
4. Fold up and secure feed hopper before moving or transporting.
5. Be sure the machine is hitched positively to the tractor and a retainer is used through the mounting pins.
6. Do not drink and drive.
7. Be a safe and courteous driver. Always yield to oncoming traffic in all situations, including narrow bridges, intersections, etc. Watch for traffic when operating near or crossing roadways.
8. Never allow riders on the machine.

2.9 STORAGE SAFETY

1. Store the unit in an area away from human activity.
2. Do not allow children to play on or around the stored machine.
3. Store the unit in a dry, level area. Support the frame with planks if required.

3 SAFETY SIGN LOCATIONS

The types of safety signs and locations on the equipment are shown in the illustrations that follow. Good safety requires that you familiarize yourself with the various safety signs, the type of warning and the area, or particular function related to that area, that requires your SAFETY AWARENESS.

- Think SAFETY! Work SAFELY!

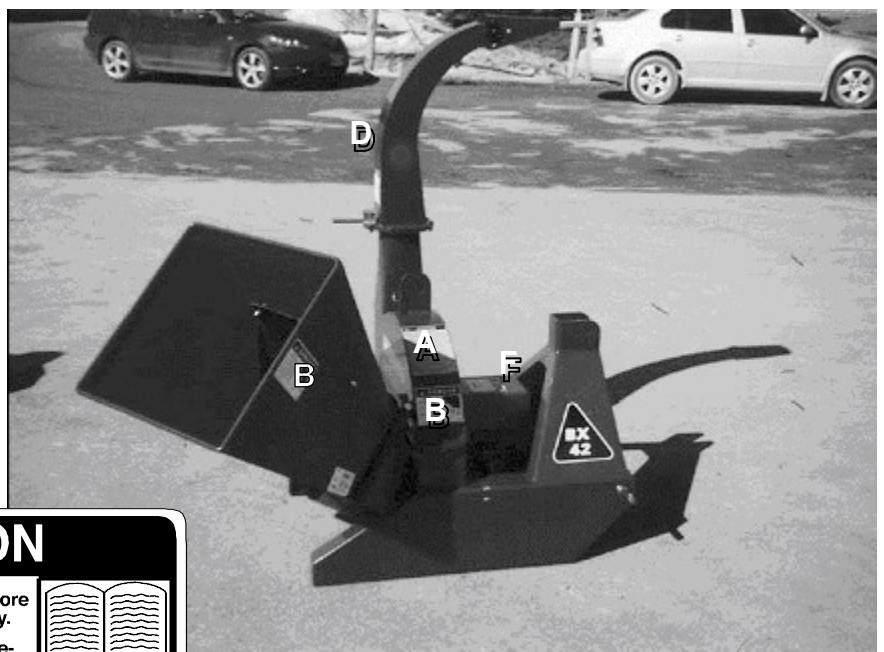

A

 **CAUTION**

- Read and understand operator's manual before starting. Review safety instructions annually.
- Turn machine off, stop and disable engine, remove ignition key and place in your pocket, set park brake and wait for all moving parts to stop before adjusting, servicing, maintaining, repairing or unplugging.
- Keep the working area clean and free of debris to prevent slipping or tripping. Operate only on level ground.
- Close and secure rotor cover before operating.
- Close and secure all guards, deflectors and shields before starting and operating.
- Keep hydraulic lines and fittings tight, in good condition and free of leaks.
- Keep hands, feet, hair and clothing away from moving parts. Never wear loose clothing around machinery.
- Keep driveline universal joint angles equal and small as possible.
- Do not point discharge at people, animals or buildings. Rotor can expel wood chips fast enough to cause injury.
- Do not allow children, animals or unauthorized people into working area.
- Do not run machine inside a closed building to prevent asphyxiation from engine exhaust.
- Use care when feeding material into chipper. Do not send metal, bottles, cans, rocks, glass or other foreign material into wood chipper. If foreign material enters chipper, stop the machine, turn engine off and place ignition key in your pocket and wait for all moving parts to stop before removing material and/or unplugging. Inspect machine for damaged or loose parts before returning to work.
- Always wear P.P.E. (Personal Protective Equipment) such as safety goggles and heavy gloves whenever operating machine.
- Do not place hands or any body parts into feed hopper during operation.
- Do not move or transport chipper when the rotor is turning.
- Do not exceed a safe travel speed when transporting. Z94006

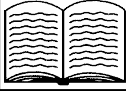

B

 **DANGER**

ROTATING CUTTING BLADES

Keep hands and feet out of inlet and discharge openings while machine is operating to avoid serious personal injury. Stop engine, remove spark plug wire and allow machine to come to a complete stop before clearing obstructions or making adjustments.

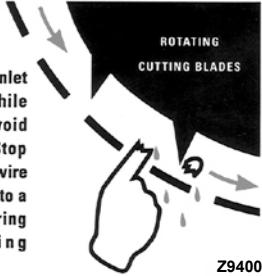

Z9400

REMEMBER - If safety signs have been damaged, removed, become illegible or parts replaced without safety signs, new signs must be applied. New safety signs are available from your authorized dealer.

The types of safety signs and locations on the equipment are shown in the illustrations that follow. Good safety requires that you familiarize yourself with the various safety signs, the type of warning and the area, or particular function related to that area, that requires your SAFETY AWARENESS.

- Think SAFETY! Work SAFELY!



C

		WARNING	
			
HIGH PRESSURE FLUID HAZARD			
To prevent serious injury or death from high-pressure fluid:			
<ul style="list-style-type: none">• Relieve pressure on system before repairing or adjusting.• Wear proper hand and eye protection when searching for leaks. Use wood or cardboard instead of hands.• Keep all components in good repair.			
<small>Z9400</small>			

REMEMBER - If safety signs have been damaged, removed, become illegible or parts replaced without safety signs, new signs must be applied. New safety signs are available from your authorized dealer.

The types of safety signs and locations on the equipment are shown in the illustrations that follow. Good safety requires that you familiarize yourself with the various safety signs, the type of warning and the area, or particular function related to that area, that requires your SAFETY AWARENESS.



D

 DANGER	
	
THROWN OBJECT HAZARD	
<p>To prevent serious injury or death from thrown objects:</p> <ul style="list-style-type: none"> • Turn machine off, stop and disable engine, remove ignition key and place in your pocket, set park brake and wait for all moving parts to stop before adjusting, servicing, maintaining, repairing or unplugging. • Do not direct discharge duct towards people, animals or property. Always wear appropriate safety gear. Keep hands and feet out of discharge openings. • Keep others away. 	
<small>Z9400</small>	

E

 DANGER	
	
MISSING GUARD HAZARD	
<ul style="list-style-type: none"> • Close and secure all guards and shields before operating. • Do not operate without guards and shields. 	
<small>Z940 3</small>	

REMEMBER - If safety signs have been damaged, removed, become illegible or parts replaced without safety signs, new signs must be applied. New safety signs are available from your authorized dealer.

The types of safety signs and locations on the equipment are shown in the illustrations that follow. Good safety requires that you familiarize yourself with the various safety signs, the type of warning and the area, or particular function related to that area, that requires your SAFETY AWARENESS.



F



REMEMBER - If safety signs have been damaged, removed, become illegible or parts replaced without safety signs, new signs must be applied. New safety signs are available from your authorized dealer.

The types of safety signs and locations on the equipment are shown in the illustrations that follow. Good safety requires that you familiarize yourself with the various safety signs, the type of warning and the area, or particular function related to that area, that requires your SAFETY AWARENESS.

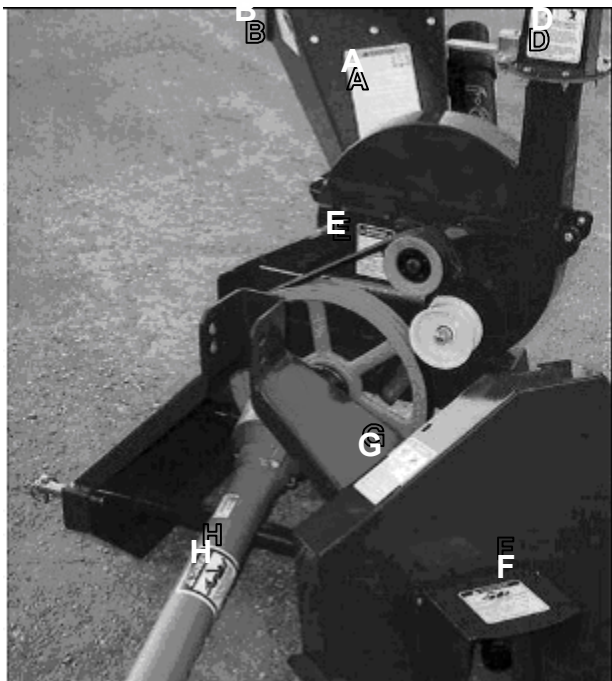
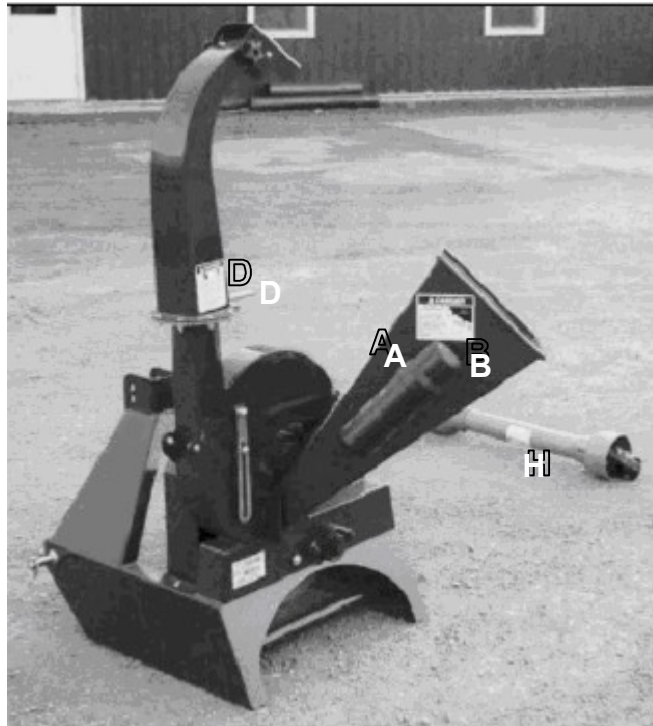
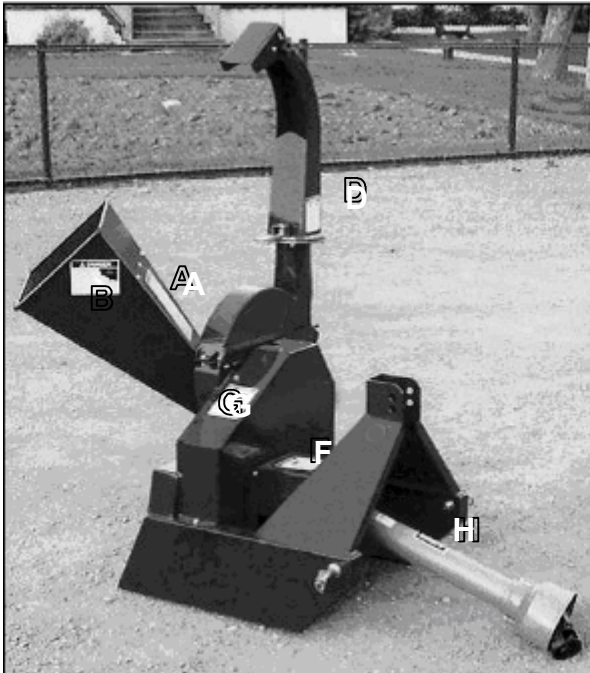

G

WARNING	
ROTATING PART HAZARD KEEP AWAY	
<p>To prevent serious injury or death from rotating parts:</p> <ul style="list-style-type: none"> • Turn machine off, stop and disable engine, remove ignition key and place in your pocket, set park brake and wait for all moving parts to stop before adjusting, servicing, maintaining, repairing or unplugging. • Close and secure guard before operating. • Keep hands, feet, hair and clothing away from moving parts. 	
<small>Z94012</small>	

REMEMBER - If safety signs have been damaged, removed, become illegible or parts replaced without safety signs, new signs must be applied. New safety signs are available from your authorized dealer.

The types of safety signs and locations on the equipment are shown in the illustrations that follow. Good safety requires that you familiarize yourself with the various safety signs, the type of warning and the area, or particular function related to that area, that requires your SAFETY AWARENESS.



H

DANGER



ROTATING DRIVELINE HAZARD
CONTACT CAN CAUSE DEATH
KEEP AWAY!

DO NOT OPERATE WITHOUT:

- ALL DRIVELINE, TRACTOR AND EQUIPMENT SHIELDS IN PLACE.
- DRIVELINES SECURELY ATTACHED AT BOTH ENDS.
- DRIVELINE SHIELDS THAT TURN FREELY ON DRIVELINE.

Z940 0

J

DANGER



GUARDS MISSING
DO NOT OPERATE

DANGER



GUARDS MISSING
DO NOT OPERATE

Z940 3

DANGER

REMEMBER - If safety signs have been damaged, removed, become illegible or parts replaced without safety signs, new signs must be applied. New safety signs are available from your authorized dealer.

4 ASSEMBLING

The machine comes from the factory in a shipping configuration. Always use tools equipment and forklifts of appropriate size and capacity for the job. Always use 2 men when lifting, moving and assembling the machine.

When the machine is shipped, follow this procedure when preparing for the customer:

1. Clear the area of bystanders especially small children before starting.
2. Use a forklift to lift the pallet/machine from the truck. Carry the load close to the ground.
3. Move the machine to the assembly area. Be sure there is sufficient clearance to access the machine from all sides.



BX32



BX42

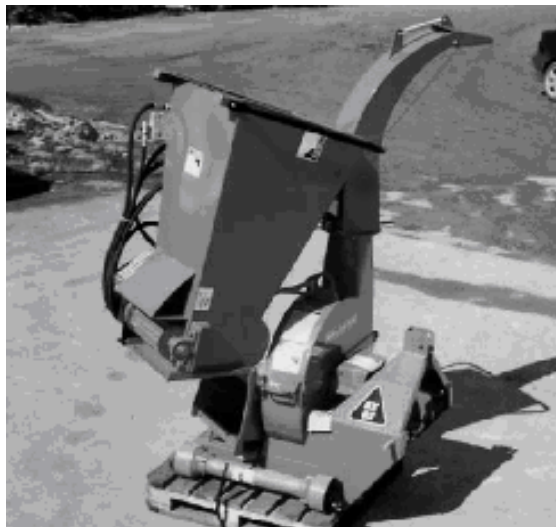

BX62

Fig. 1 SHIPPING

4. Cut the tie-down straps.



Fig. 2 TIE-DOWNS

5. Lay-out components next to machine.



BX32



BX62

Fig. 3 LAY-OUT

6. Use a forklift to raise and lift the frame.

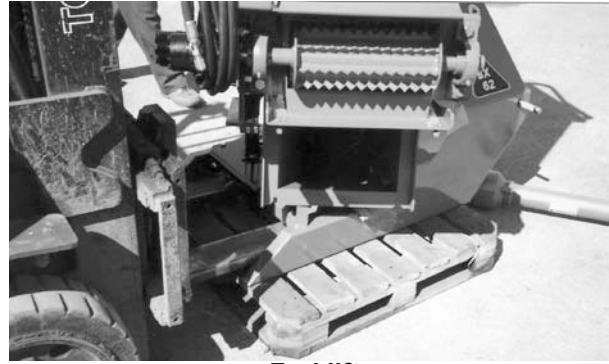

Forklift

7. Or alternatively attach a lifting device to the lifting bracket on top of the frame.

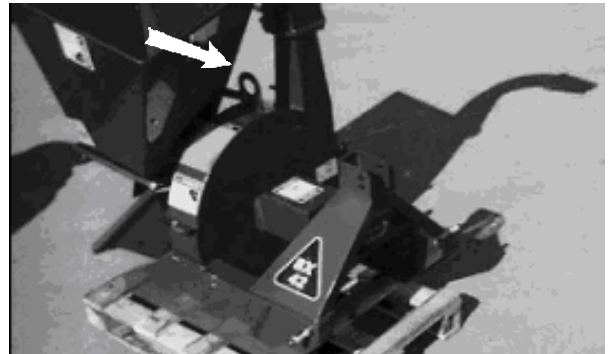

Bracket

Fig. 4 LIFTING

8. Remove pallet and place machine on the ground.

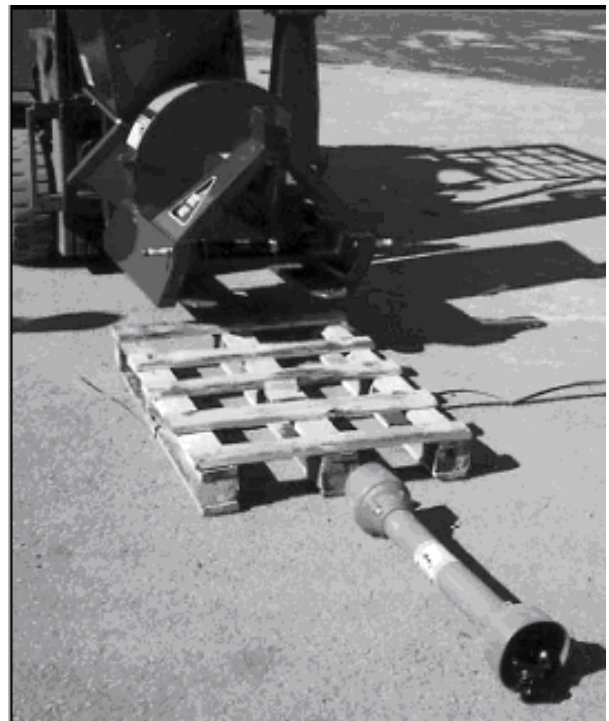

Fig. 5 PALLET REMOVED

9. Release feed hopper transport latch and lower hopper into the working position. Stow anchor latch.

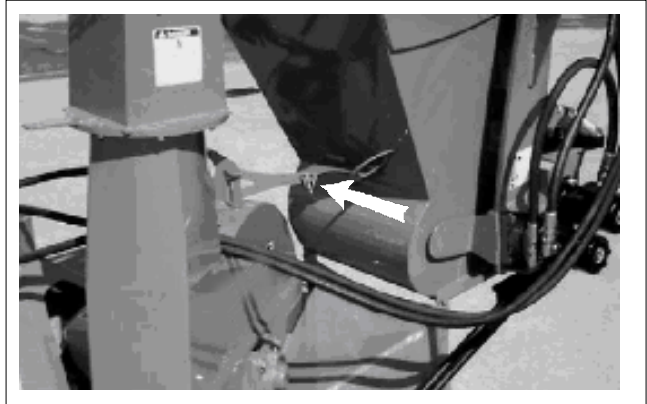

Fig. 6 HOPPER TRANSPORT LATCH

10. Tighten anchor bolts to their specified torque.

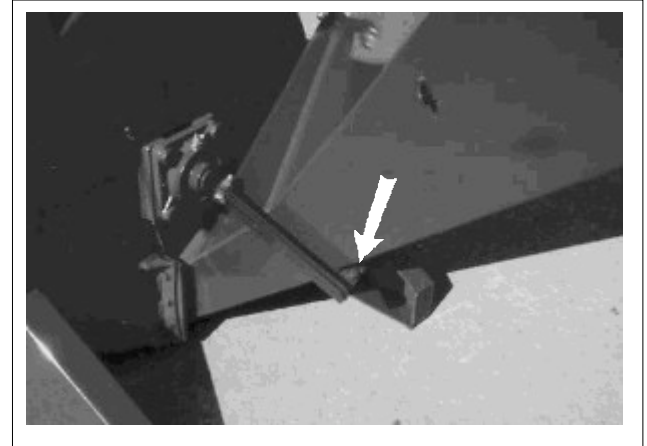

Fig. 7 ANCHOR BOLTS (TYPICAL)

11. **Connect the PTO drive line:**

- a. Raise the input shaft guard.
- b. Check that the drive line telescopes easily and that the shield rotates freely.
- c. Attach the drive line to the chipper input shaft by depressing the lock pin, slide yoke over the shaft and pushing on the yoke until the lock pin clicks into position.

NOTE

Be sure the yoke with the shear pin is attached to the machine shaft.

- d. Lower the guard to cover the input shaft.

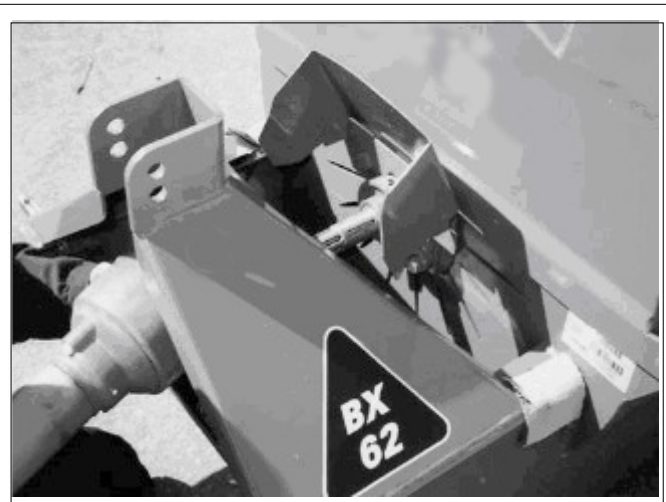

Aligning



Installed

Fig. 8 DRIVELINE (TYPICAL)

12. Depress handle on discharge chute latch and turn assembly to its desired position. Turn until latch seats in its detent.

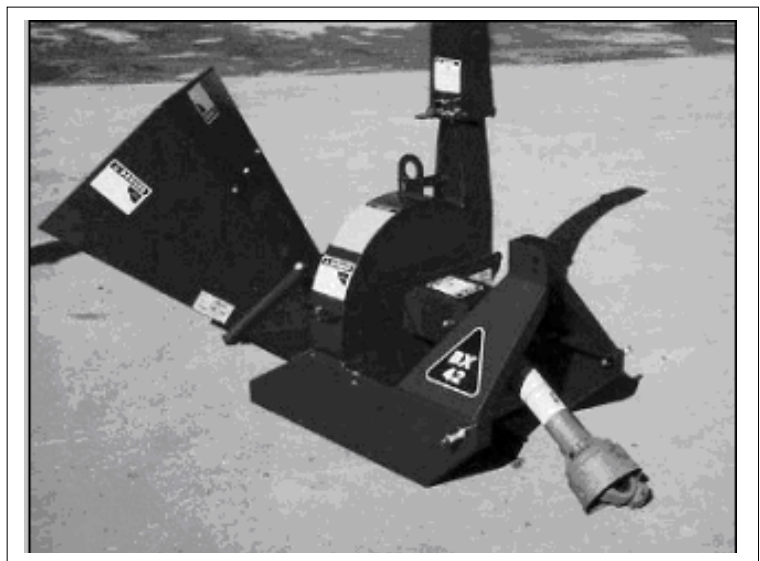

Fig. 9 DISCHARGE CHUTE

5 OPERATION



OPERATING SAFETY

- Please remember it is important that you read the operator's manual and heed the safety signs on the 3 Point Hitch Wood Chipper. They are there for your safety, as well as the safety of others. The safe use of this machine is strictly up to you, the operator.
- Personal protection equipment including hearing protection, hard hat, safety glasses, safety shoes, and gloves are recommended during assembly, installation, operation, adjustment, maintaining, repairing, or plugging. Do not allow long hair, loose-fitting clothing, or jewellery to be around moving parts.
- Turn machine off, stop and disable engine, remove ignition key and place in your pocket, set park brake and wait for all moving parts to stop before servicing, adjusting, repairing or unplugging.
- Do not run machine inside a closed building to prevent asphyxiation from engine exhaust.
- Use care when feeding material into chipper. Do not send metal, bottles, cans, rocks, glass or other foreign material into wood chipper. If foreign material enters chipper, stop machine, turn engine off and place ignition key in your pocket and wait for all moving parts to stop before removing material and/or unplugging. Inspect machine for damaged or loose parts before resuming work.
- Never use alcoholic beverages or drugs which can hinder alertness or coordination while operating this equipment. Consult your doctor about operating this machine while taking prescription medications.
- Do not allow riders on this machine at any time. There is no safe place for any riders.
- Never allow children or unauthorized people to operate or be around this machine.
- Do not reach into rotor or feed hopper openings when the engine is running. Install and secure access covers before starting engine.
- Do not move or transport chipper when the rotor is turning.
- Do not exceed a safe travel speed when transporting.
- Keep hydraulic lines and fittings tight, in good condition and free of leaks.
- Keep the working area clean and free of debris to prevent tripping. Operate only on level ground.
- Do not point discharge at people, animals or buildings. Rotor can expel wood chips fast enough to cause injury.

5.1 TO THE NEW OPERATOR OR OWNER

The 3 Point Hitch Wood Chippers are designed to chip or chop scrap lumber, small trees, brush, limbs and other wood debris. The chipped material is fine enough to be composted or used in a variety of ways.

It is the responsibility of the owner or operator to read this manual and to train all other operators before they start working with the machine. Follow all safety instructions exactly. Safety is everyone's business. By following recommended procedures, a safe working environment is provided for the operator, bystanders and the area around the work site. Untrained operators are not qualified to use the machine.

Follow all safety instructions exactly. Safety is everyone's business. By following recommended procedures, a safe working environment is provided for the operator, bystanders and the area around the work site. Untrained operators are not qualified to operate the machine.

Many features incorporated into this machine are the result of suggestions made by customers like you. Read this manual carefully to learn how to use the chipper safely and how to set it to provide maximum field efficiency. By following the using instructions in conjunction with a good maintenance program, your 3 Point Hitch Wood Chipper will provide many years of trouble-free service.

5.2 MACHINE COMPONENTS

The 3 Point Hitch Wood Chipper is a rotor with blades for chipping wood. A hinged feed hopper moves the wood material into the rotor.

Each rotor is designed with 4 blades and a twig-breaker to generate the small pieces of wood. A stationary knife at the rear of the rotor housing is placed by the moving knives to shear, chip or chop the material.

The tractor provides rotational power through a PTO shaft on the front of the frame and hydraulic power for the hydraulic feed hopper.

- A Manual Feed Hopper
- B Discharge Hood
- C Rotor Housing
- D Rotor Blade
- E Stationary Blade
- F Twig Breaker
- G Hood Deflector
- H Hydraulic Feed Hopper
- J Hydraulic Feed Control
- K Hydraulic Motor
- L PTO Driveline
- M Rotor
- N Paddle
- O 3 Point Hitch

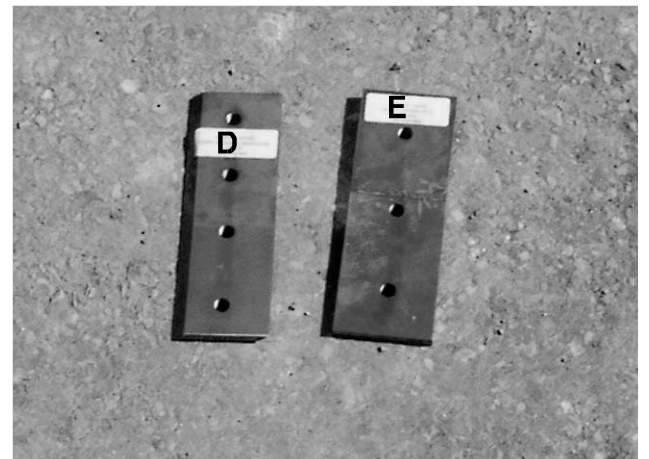
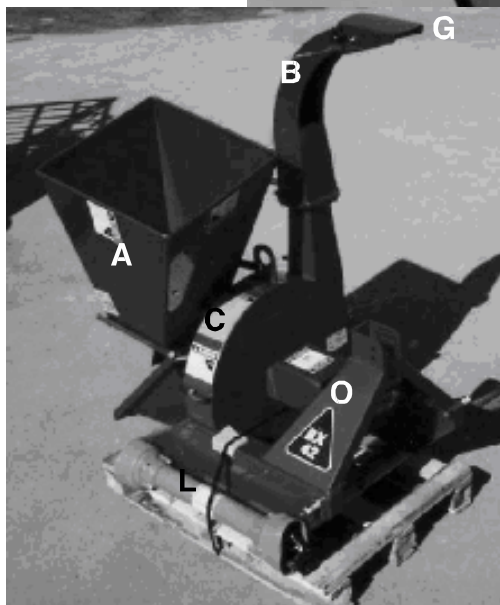
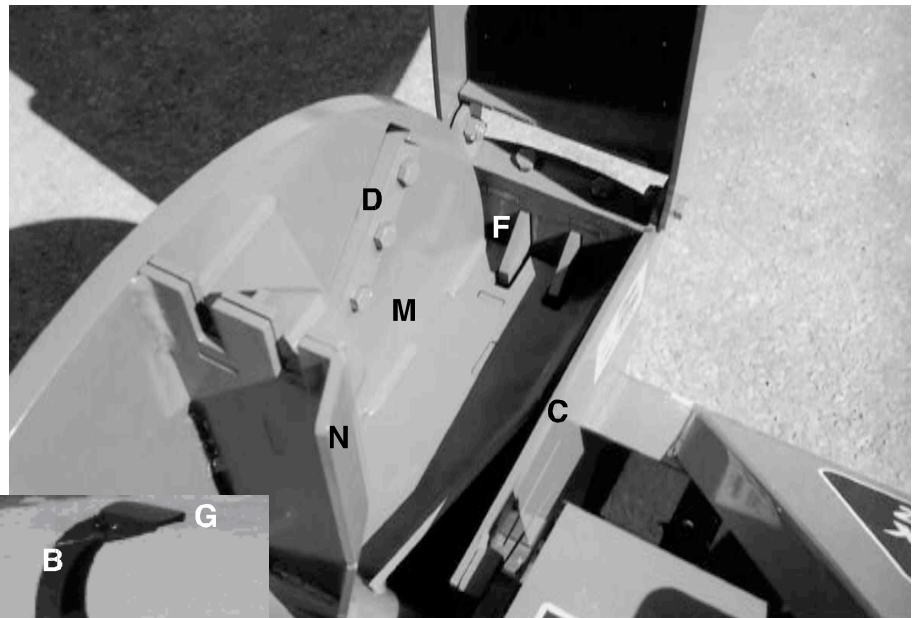
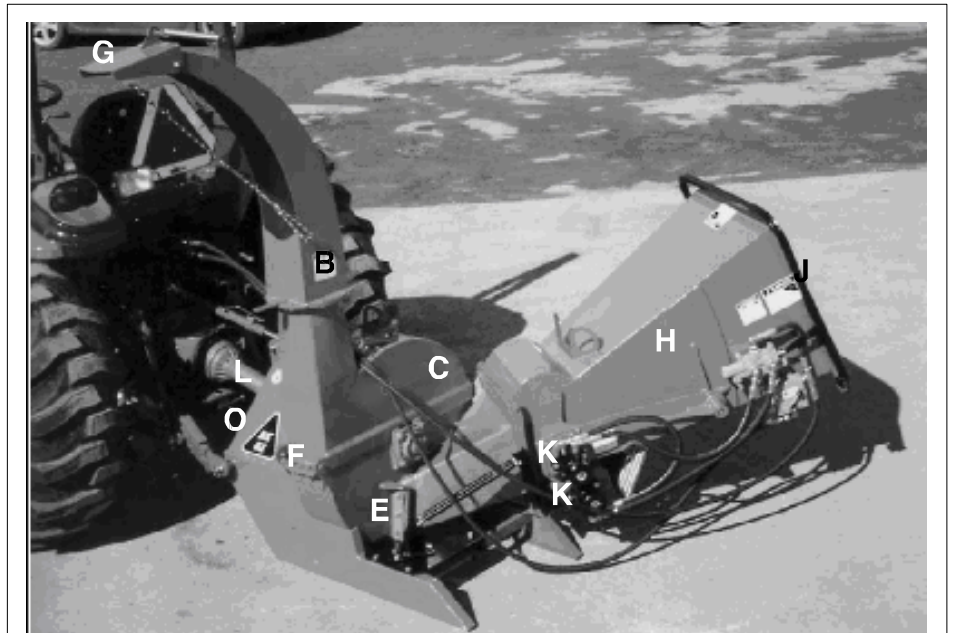

Fig. 10 PRINCIPLE COMPONENTS

5.3 MACHINE BREAK-IN

Although there are no operational restrictions on the Wood Chipper when used for the first time, it is recommended that the following mechanical items be checked:

A. After operating for 1 hour:

1. Torque all fasteners and hardware.
2. Check condition of rotor bearings.
3. Check the condition and clearance of the twig-breaker, rotor and stationary blades. Adjust or replace as required.
4. Check for entangled material. Remove all entangled material before resuming work.
5. Lubricate all grease fittings.

B. After operating for 10 hours:

1. Repeat steps 1 through 5 listed above. (Section A)
2. Go to the normal servicing and maintenance schedule as defined in the Maintenance Section.

5.4 PRE-OPERATION CHECKLIST

Efficient and safe operation of the 3 Point Hitch Wood Chipper requires that each operator reads and understands the using procedures and all related safety precautions outlined in this section. A pre-operation checklist is provided for the operator. It is important for both the personal safety and maintaining good mechanical condition that this checklist is followed.

Before operating the Wood Chipper and each time thereafter, the following areas should be checked off:

1. Lubricate the machine per the schedule outline in the Maintenance Section.
2. Check the rotor, blades and twig-breaker. Remove any twine, wire or other material that has become entangled.
3. Check the condition and clearance of the twig-breaker, rotor and stationary blades. Adjust or replace as required.
4. Check that all bearings turn freely. Replace any that are rough or seized.
5. Make sure that all guards and shields are in place, secured and functioning as designed.
6. Check the condition of the curtain in the feed hopper. It must be in good condition to prevent chips from flying out.

5.5 DRIVELINE DIMENSION

A PTO drive line is supplied with the machine. To accompany the variety of 3 point hitch geometry available today, the drive line can be too long for most machines

or too short for others. It is very important that the drive-line be free to telescope but not to bottom out when going through its working range. If the drive line bottoms out, the bearings on both the machine and tractor PTO shaft will be overloaded and fail in a short time.

1. **To determine the proper length of the drive-line, follow this procedure:**
 - a. Clear the area of bystanders, especially small children.
 - b. Attach the chipper to the tractor (see section 5.8) but do not attach the driveline.
 - c. Raise the machine until the input shaft is level with the tractor PTO shaft.
 - d. Measure the dimension between the locking grooves on the tractor PTO shaft and the machine input shaft.
 - e. Measure the same dimensions on the compressed driveline.
 - f. If the compressed driveline dimension exceeds the machine dimension, the driveline will have to be cut.
2. **When cutting the driveline, follow this procedure:**
 - a. Subtract the machine dimension (A) from the uncut driveline dimension (B) or (B-A). This dimension determines how much too long the driveline is.
 - b. Add another inch (25 mm) to the dimension to be sure it doesn't bottom out, to determine (C) the cut off dimension.
 - c. Use a hacksaw to cut dimension (C) from both ends. Cut both the plastic tubes and the metal cores.
 - d. Use a file to remove the burrs from the edges that were cut.
 - e. Assemble the 2 ends of the shaft.
 - f. Make sure the shaft can telescope freely. If it does not, separate the 2 parts and inspect for burrs or cuttings on the shaft ends. Be sure it telescopes freely before installing.

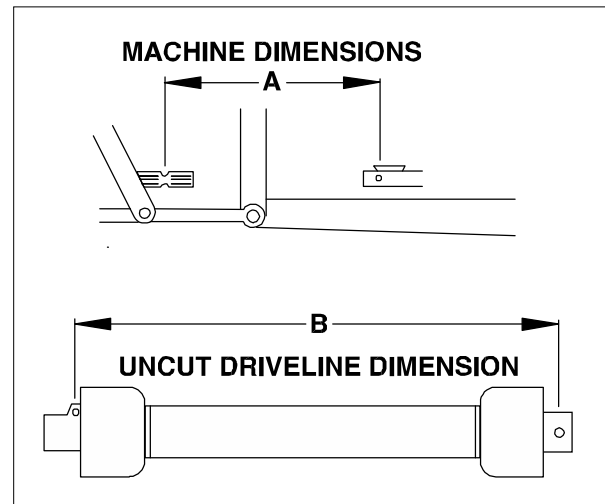

Fig. 11 DRIVELINE DIMENSIONS

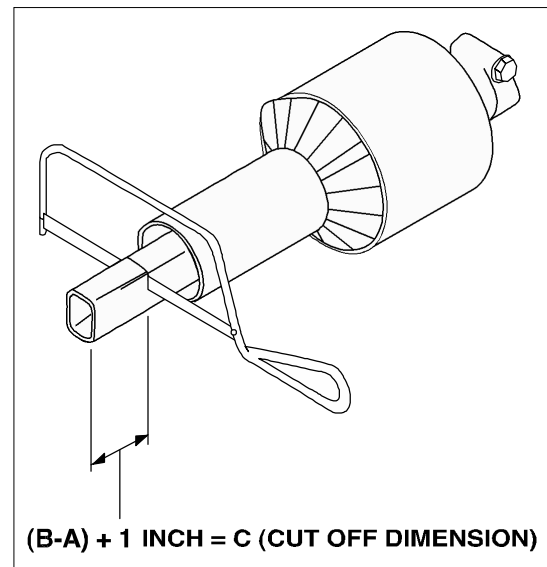

Fig. 12 CUT OFF DIMENSION

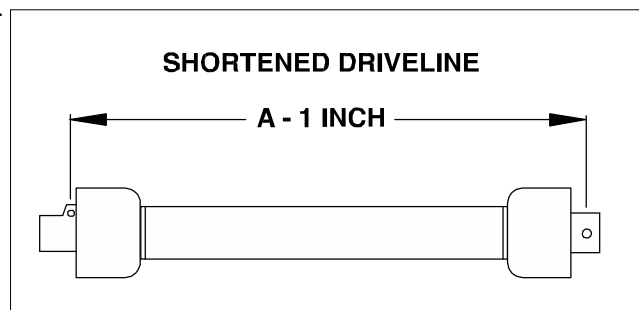

Fig. 13 SHORTENING

5.6 MOUNTING AND UNHOOKING TRACTOR

When attaching chipper to a tractor, follow this procedure:

1. Clear the area of bystanders, especially small children.
2. Make sure there is enough room and clearance to safely back up to the chipper.
3. Place the tractor arms in their full sway position.
4. Back up slowly and align the lower link arms to the pins on the machine.
5. Mounting without a Quick Hitch
 - a. Align the left lower link with the left chipper pin.

IMPORTANT

It may be necessary to add weight to the lower lift arms to bring them to the required height.

- b. Insert the left pin through the ball and install the retainer.
- c. Align the right arm to the pin by turning the jack screw on the arm.
- d. Insert the right pin through the ball and install the retainer. Return the jack-screw to its starting position.
- e. Remove the top pin and install the top link. Use the turnbuckle to align the top link. Insert the pins and install the retainers. Return the turnbuckle to its original length and lock.

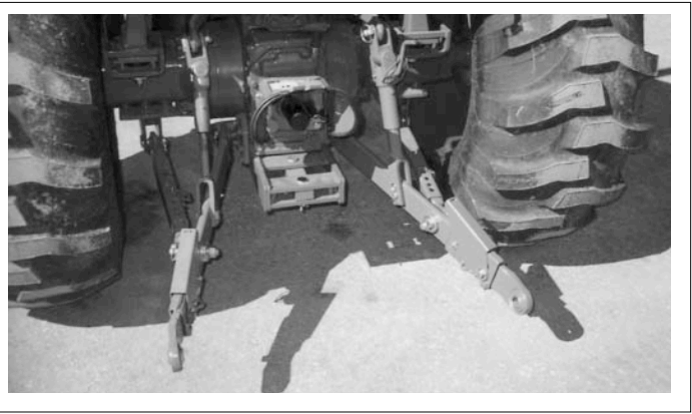

Fig. 14 TRACTOR LOWER LINKS



Aligned



Pinned

Fig. 15 LOWER ARMS



Fig. 16 TOP LINK

5. Mounting with a Quick Hitch.
 - a. Align the claws on the Quick Hitch slightly below the mounting pins on the chipper.

IMPORTANT

It may be necessary to add weight to the lower lift arms to bring them to the required height.

- b. Back up until the pins are above the claws.
 - c. Use the turnbuckle on the top link to adjust the position of the top claw.
 - d. Raise the 3 point hitch until the pins seat in the claws.
 - e. Be sure the retainers are released to hold the pins in the claws.
6. Set the 3 point hitch in the non-sway position (see tractor manual for details).

7. Install the PTO driveline:

NOTE

Be sure the telescoping portion of the shaft is greased and free of dirt.

- a. Slide the collar back on the yoke, align the splines and slide the yoke on the tractor.
- b. Release the collar and make sure the locking pin clicks into position.

NOTE

The driveline should already have been cut to the required length.



Fig. 17 PTO SHAFT

8. Connect the hydraulics:

- a. Use a clean rag or paper towel to clean the dirt from couplers on the hose ends and the tractor.
- b. Connect the hoses to the tractor couplers. Be sure the couplers are securely seated.
- c. Route and secure the hoses along the hitch with clips, tape or plastic ties to prevent binding and pinching. Be sure to provide slack for turning.

NOTE

Always connect to the hydraulic circuit with a detent.



Fig. 18 HYDRAULICS

 WARNING	
	
HIGH PRESSURE FLUID HAZARD To prevent serious injury or death from high-pressure fluid:	
<ul style="list-style-type: none">• Relieve pressure on system before repairing or adjusting.• Wear proper hand and eye protection when searching for leaks. Use wood or cardboard instead of hands.• Keep all components in good repair.	

9. Slowly raise the machine through its working range to make sure the telescoping portion of the PTO shaft doesn't bottom out.
10. Level the machine front and rear, and side to side using the jackscrew on the right arm and the turnbuckle on the top link.

The chipper should always be level on the ground in its working position.

11. To unhook from the tractor, reverse the above procedure. Always park the machine in a dry, level area. If vandalism is a problem, remove the PTO driveline and store in a secure place.



Fig. 19 LEVELLING ADJUSTMENTS

5.7 CONTROLS

All controls are conveniently positioned next to where the operator would stand when feeding the machine to provide easy operation. Review this section to familiarize yourself with the location and function of each control before starting.

1. Hydraulic Feed Control Lever:

This lever is positioned to extend around the feed hopper and provides access from all sides. It is only available when the chipper is equipped with the optional hydraulic feed hopper.

Pull the control all the way out to engage the feeding system. Push in slightly to the first detent to stop the feeding system. Push the control all the way in to reverse the feeding system.

NOTE

Use the typical flow divider next to the control valve to set the feeding spread.

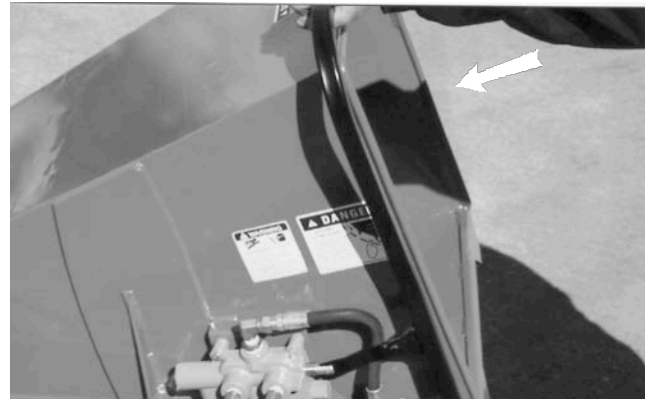

Feeding



Neutral/Stop



Reversing

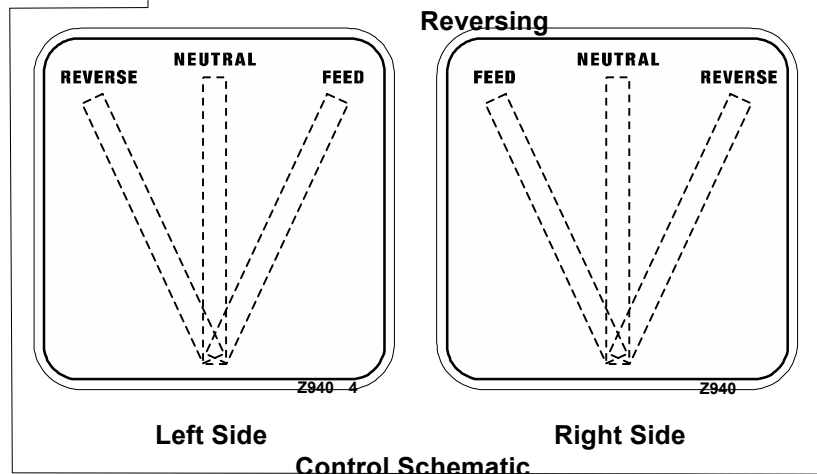

Fig. 20 HYDRAULIC FEED CONTROL LEVER

2. **Deflector Position:**

Each discharge hood is equipped with a deflector on the end to place the chips exactly where desired. There are 2 types available:

- a. **Manual Clamp (BX42):**
The deflector is held in place by clamping bolts on each side. Loosen the clamps, move the deflector and tighten the clamps. Position as desired.
- b. **Spring-Loaded (BX62):**
The deflector is spring-loaded up and held in place by a chain. Release the chain from its anchor bracket and move the deflector to its desired position. Secure chain in its anchor bracket.

3. **PTO Control:**

If you are not familiar with the location of the PTO control on your tractor, review your tractor's Operator's Manual. Always engage the PTO control slowly when the engine is running at low idle RPM. Disengage the PTO control slowly at low RPM to allow the machine to slow and stop before engaging the PTO brake. Remember the PTO drives the rotor. When the PTO is engaged the rotor will also start to turn.

4. **Flow Control Valve:**

This manually-set flow divider allows the operator to set the flow through the circuit from 0% to 100% by dumping the excess flow back to the tractor. A scale on the face of the valve is numbered from 0 to 10 to define the percent of flow from 0 to 100% flowing into the circuit. The hydraulic feed circuit is equipped with a flow divider so the operator can adjust the feeding speed appropriate for the operating conditions. Loosen the lock and move the pointer arm to the desired position. Tighten the lock bolt. Adjust in small increments as a small change can result in a large change to feeding speed.



Manual Clamp



Spring-Loaded

Fig. 21 DEFLECTOR POSITION



Fig. 22 FLOW CONTROL VALVE

5.8 FIELD OPERATION



OPERATING SAFETY

- Please remember it is important that you read the operator's manual and heed the safety signs on the 3 Point Hitch Wood Chipper. They are there for your safety, as well as the safety of others. The safe use of this machine is strictly up to you, the operator.
- Personal protection equipment including hearing protection, hard hat, safety glasses, safety shoes, and gloves are recommended during assembly, installation, operation, adjustment, maintaining, repairing, or plugging. Do not allow long hair, loose-fitting clothing, or jewellery to be around moving parts.
- Turn machine off, stop and disable engine, remove ignition key and place in your pocket, set park brake and wait for all moving parts to stop before servicing, adjusting, repairing or unplugging.
- Do not run machine inside a closed building to prevent asphyxiation from engine exhaust.
- Use care when feeding material into chipper. Do not send metal, bottles, cans, rocks, glass or other foreign material into wood chipper. If foreign material enters chipper, stop machine, turn engine off and place ignition key in your pocket and wait for all moving parts to stop before removing material and/or unplugging. Inspect machine for damaged or loose parts before resuming work.
- Never use alcoholic beverages or drugs which can hinder alertness or coordination while operating this equipment. Consult your doctor about operating this machine while taking prescription medications.
- Do not allow riders on this machine at any time. There is no safe place for any riders.
- Never allow children or unauthorized people to operate or be around this machine.
- Do not reach into rotor or feed hopper openings when the engine is running. Install and secure access covers before starting engine.
- Do not move or transport chipper when the rotor is turning.
- Do not exceed a safe travel speed when transporting.
- Keep hydraulic lines and fittings tight, in good condition and free of leaks.
- Keep the working area clean and free of debris to prevent tripping. Operate only on level ground.
- Do not point discharge at people, animals or buildings. Rotor can expel wood chips fast enough to cause injury.

Although the 3 Point Hitch Wood Chipper is easy to use, each operator should review this section to familiarize himself with the detailed safety and operating procedures. When using this machine, follow this procedure:

1. Clear the area of bystanders, especially small children.
2. Review and follow the Pre-Operation Checklist (see Section 5.4).
3. Attach the machine to the tractor (see Section 5.6).

4. Drive to the work area and position at the work site.
5. Set park brake.
6. Stop engine.
7. Remove ignition key and place in your pocket.
8. Move the feed hopper down into its working configuration and secure with the anchor nuts.
9. Turn discharge hood to its working position.



Fig. 23 FEED HOPPER/DISCHARGE HOOD

10. Starting the Machine:

- a. Start the tractor engine.
- b. Move the throttle to its low idle position.
- c. With the engine at low idle, slowly engage the PTO control.
- d. Slowly increase the engine speed until the PTO is at rated speed.
- e. With the manual feeding model, start feeding material into the hopper.
- f. With the hydraulic feeding model:
 - Place the tractor hydraulic lever into its detent position.
 - Move the control lever into the feed position.
 - Start feeding material into the hopper.



Hydraulic Feed

11. Stopping:

- a. Stop feeding material into the hopper.
- b. Place the hydraulic feed control in off/neutral.
- c. Slow engine RPM.
- d. Place hydraulic lever in its OFF position.
- e. Disengage PTO.
- f. Stop engine, remove ignition key and place in your pocket and wait for all moving parts to stop.



Working

Fig. 24 STARTING/STOPPING

12. Emergency Stopping:

Stop tractor engine if an emergency occurs. Correct emergency situation before starting engine and resuming work.

13. Feeding:

a. Manual Feed:

- Slowly slide the wooden material into the feed hopper and move it into the rotor.
- Do not push the material with a lot of force into the rotor.
- Do not push the material too fast into the rotor. Stop and slow down if the engine starts to slow down.
- Do not reach into the feed hopper further than the curtain to be sure not to contact the blades on the rotor.
- Use a stick or branch to push any piece of material into the rotor that does not move on its own and stops in the hopper. Do not take a chance with getting your hand caught in the rotor.

b. Hydraulic Feed:

- Slowly slide the wooden material into the feed hopper until the roller grabs the material and move it into the rotor.
- Use the flow divider on the side of the feed hopper to set the feeding speed.
- Do not reach into the feed hopper further than the curtain to be sure not to contact the feed roller or the blades on the rotor.
- Use a stick or branch to push any piece of material into the feed roller that does not move on its own and stops in the hopper. Do not take a chance with getting your hand caught in the feed roller.

14. Always wear personal protective equipment (PPE) whenever operating the machine. This includes but is not limited to protective shoes with slip resistant soles, protective goggles or face shield, heavy gloves, hearing protection and protective clothing.



Fig. 25 OPERATING

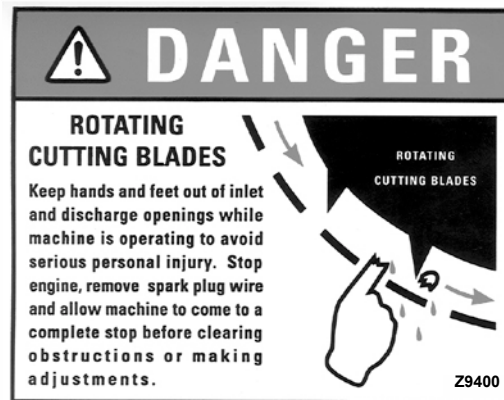

15. Do not place metal, bottles, cans, rocks, glass or other solid material into the wood chipper. If something like this gets into the machine, stop the machine immediately for a detailed inspection. Stop engine, remove ignition key and place in your pocket and wait for all moving parts to stop before inspecting or unplugging. Inspect machine for damaged or loosened parts before resuming work.

16. Blades:

There are 2 types of blades used on the Wood Chipper. They work together to cut, shear and shred the wood as it moves through the machine.

a. **Rotor blades:**

The rotor is equipped with 4 blades placed at 90° to each other to keep the rotor in balance. If one needs to be changed, the one opposite should be changed.

b. **Stationary blade:**

Each machine is equipped with a stationary blade that acts as a stop for the moving rotor blades.

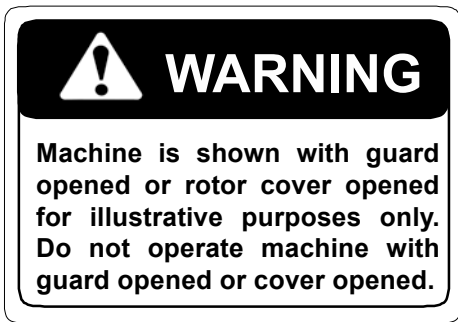

17. Clearance:

It is recommended that the clearance between the rotor and stationary blades be set and maintained at 1/32 inch to obtain the best performance. Use the stationary blade mounting bolts to set the clearance as required.

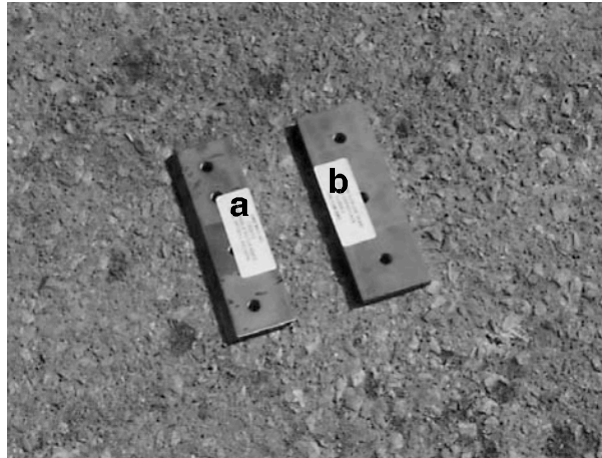

a. Rotor b. Stationary

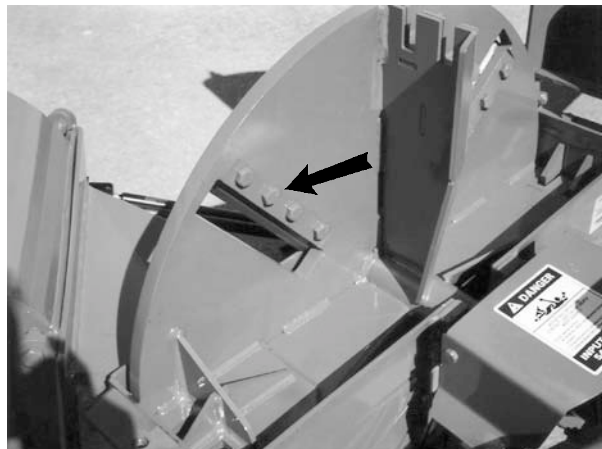

Rotor

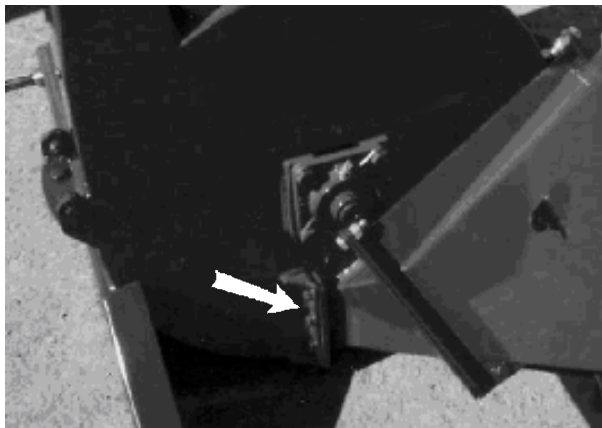

Stationary

Fig. 26 BLADES

18. Twig Breaker:

Each machine is equipped with a twig breaker to break up twigs or other long material as it moves through the rotor compartment. Open the rotor cover and check the condition of the breaker on a weekly basis. Also check for any entangled material when the rotor cover is opened. Remove this material prior to closing the cover and resuming work.

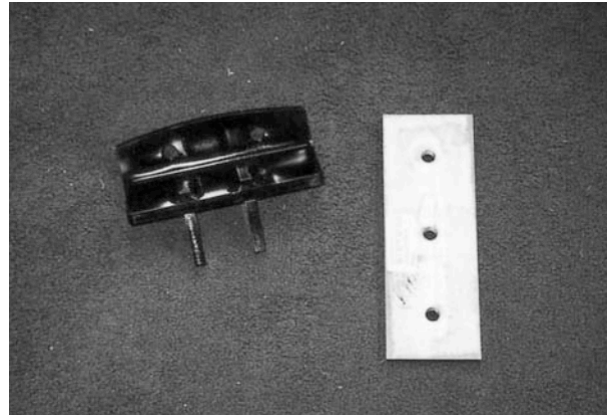

Disassembled

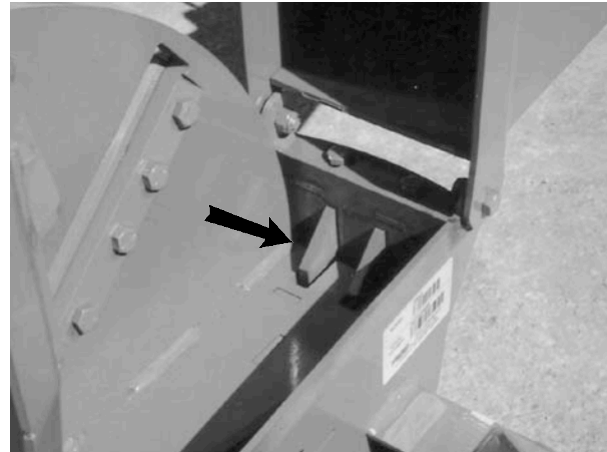

Double

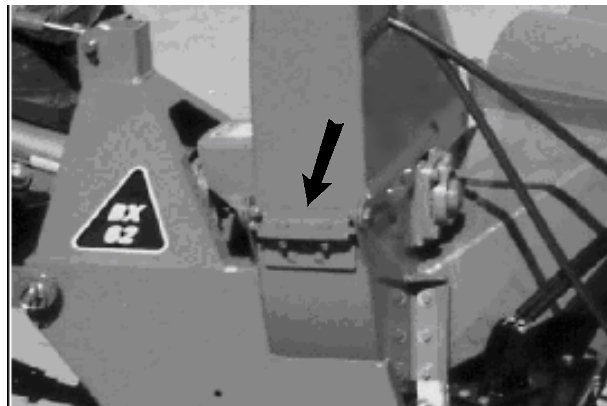

Mounting

Fig. 27 TWIG BREAKER

19. Shear Pin:

The PTO driveline is designed with a shear pin at the input yoke to prevent overloading the drive system. Remove the broken parts from the yoke when the pin shears and replace with genuine parts.

The drive system is designed to function well without failing the shear pin. If it does fail, generally it is being fed too fast or something very hard has been jammed into the rotor or between the blades. Always unplug the system and determine the cause of the problem and correct it before resuming work.

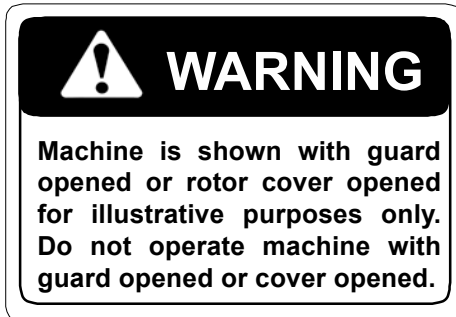

BX32

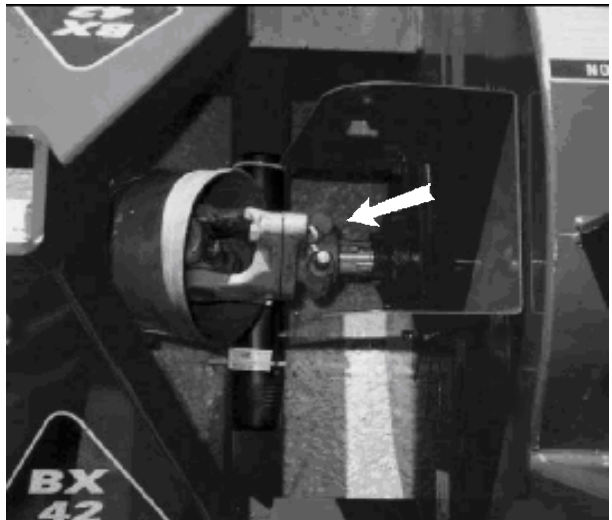

BX42

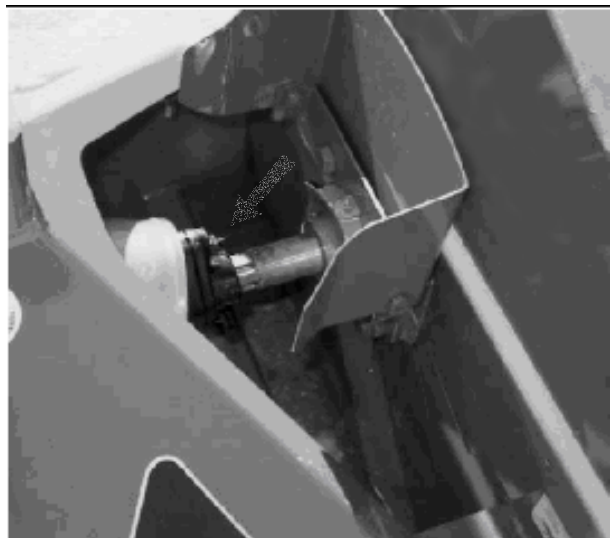

BX62

Fig. 28 SHEAR PIN

20. Unplugging:

Although the machine is designed to handle a wide variety of material without any problem, occasionally it plugs. When the machine plugs, follow this procedure to unplug:

- a. Clear the area of bystanders, especially small children.
- b. Stop the engine, remove the ignition key and place it in your pocket and wait for all moving parts to stop before unplugging.
- c. Pull the material out of the feed hopper or reverse the hydraulic feed hopper. Be sure all the material is out and nothing is jammed or wedged between the input opening and the rotor.
- d. Pull the material out of the discharge hood. Use a stick to poke loose any material jammed into the discharge hood. Do not allow anything to remain in this area.
- e. **Severe plug:**
 - Loosen the feed hopper anchor nuts and raise the feed hopper. Remove material from inside the rotor compartment.
 - Clean out the discharge area/rotor.
 - Open the rotor cover and clean out the housing. Be sure to turn the rotor by hand to be sure there is nothing jammed between the rotor and stationary blades.
 - Close, install and fold down all components opened to unplug. Tighten fasteners to their specified torque.
- f. Check that everyone is clear of machine before restarting engine.
- g. Start the engine, engage the PTO and resume working.

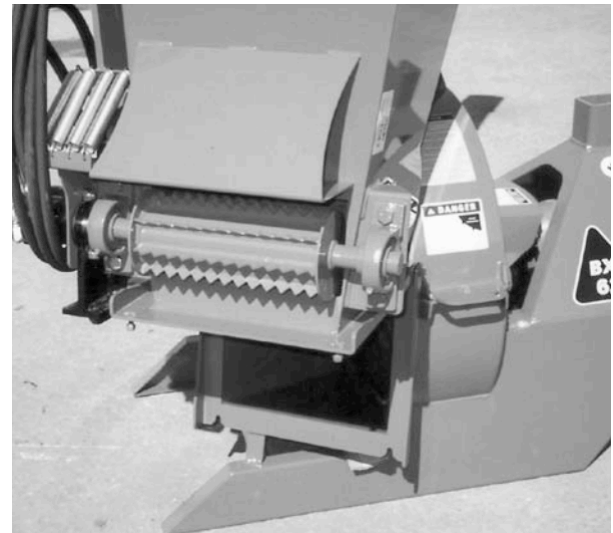

Feed Hopper

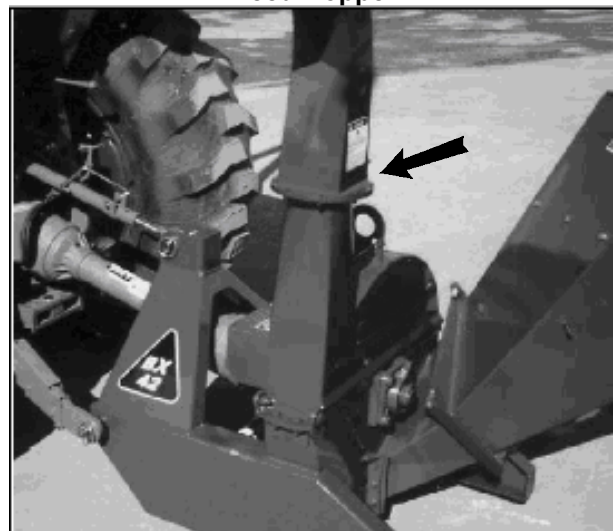

Discharge Hood



Rotor Cover

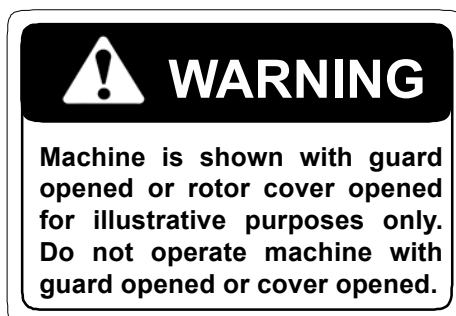

Fig. 29 SEVERE PLUG

21 . Cleaning:

Clean the machine frequently to prevent a build-up of dust, chips and trash on the frame. A clean machine reduces the chance of rusting.

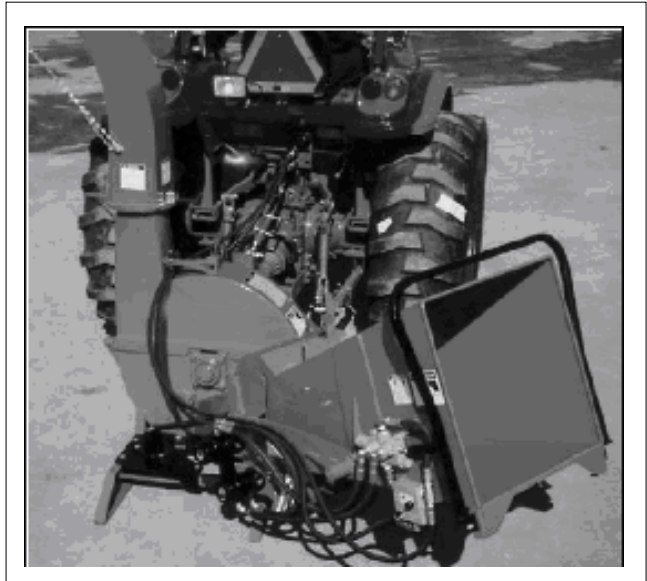

Fig. 30 CLEANING

22. Curtains:

Each feed hopper is designed with an internal rubber/belting curtain to prevent chips and debris from coming out of the hopper when working. Check the condition of the curtain each day prior to starting. Replace the curtain if torn, damaged or missing to minimize the chance of material coming out of the feed hopper.

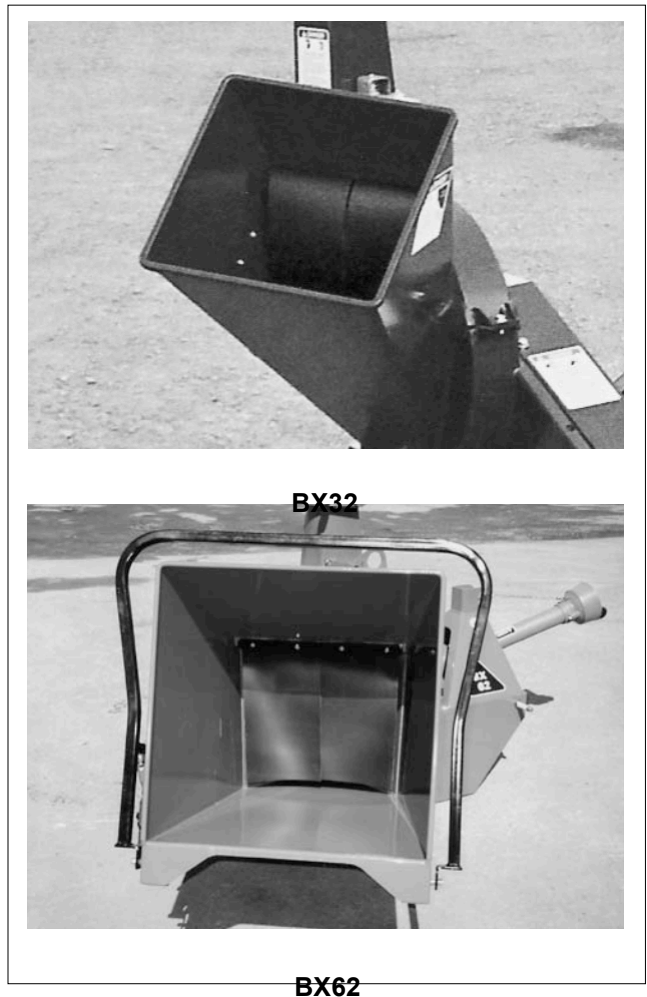
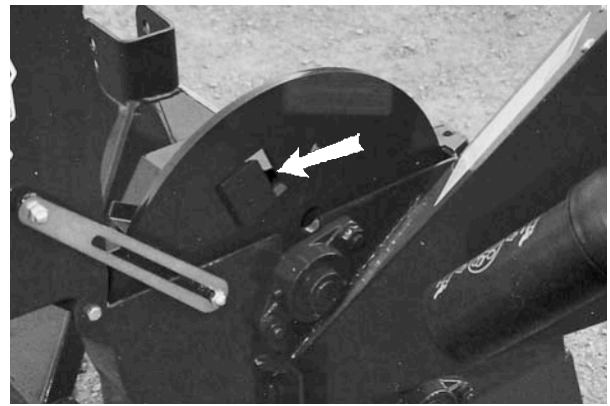

Fig. 31 CURTAIN

23. Sharpening Blades:

The rotor and stationary blades need to be sharp for the chipper to perform as expected. It is recommended that the rotor blades be removed from the rotor when sharpening. Always sharpen the blades at a 45° angle to provide the best cutting effect as it meets the stationary blade. Be sure to tighten the blade mounting bolts to their specified torque when re-installing the blades to the rotor.

The stationary blade is designed with 4 sharp corners that can be utilized. When the corner facing the rotor blade rounds over, remove the blade and re-install with a different corner facing the rotor blade. Use the stationary blade to set the clearance to the rotor blade when re-installing. Be sure to tighten mounting bolts to their specified torque.



BX32

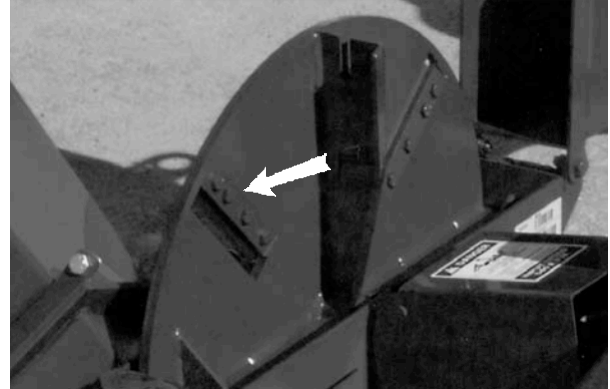

BX42

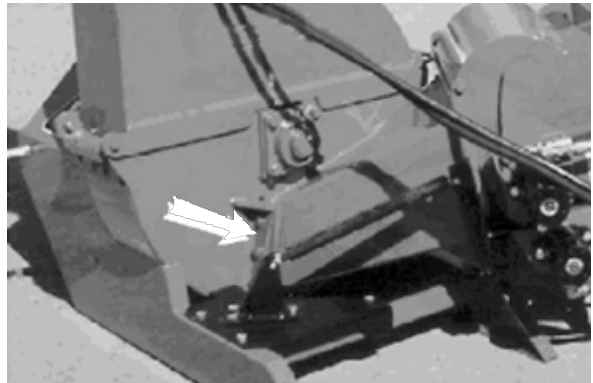

Stationary



a. Rotor

b. Stationary

Fig. 32 BLADES

24. Hydraulic Feed Control:

The machine with the hydraulic feed hopper is designed with a control lever to place the hopper in FEED - OFF/NEUTRAL - REVERSE. Pull all the way out to feed, push in to the first detent for off or neutral and fully in for reverse. In reverse the material in the hopper is pulled out of the rotor. Use reverse when the rotor is overloaded, jammed or plugged.

IMPORTANT

Check the function of the control lever when attaching the hydraulic lines to the tractor. The hopper must feed in when the lever is moved out. If it does not, reverse the hoses. **The control lever must function like the drawing on each side of the hopper or the hoses must be reversed.**

Use the flow divider valve to set the speed of the feed hopper. Use the quality of the job being done to establish the required feed speed. Increase the speed when chipping brush or twigs. Decrease the speed when chipping hard, solid material or when the engine is being pulled down.

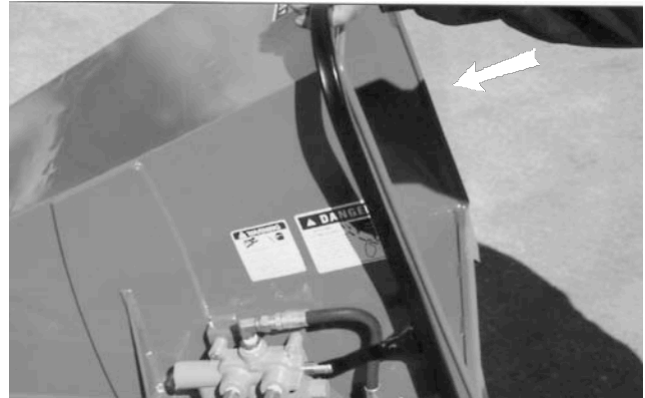

Feeding



Neutral/Stop



Reversing

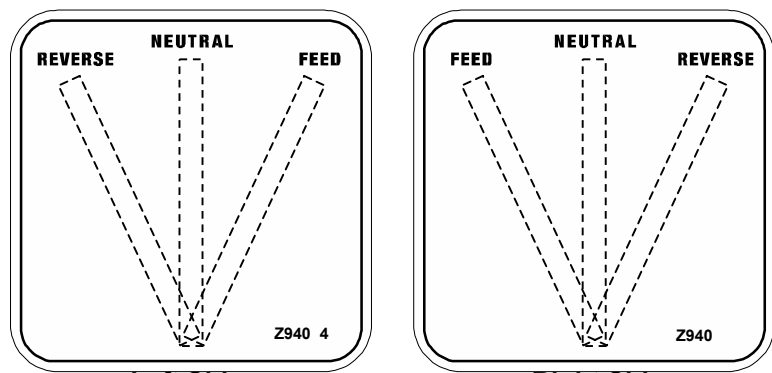

Control Schematic

Fig. 33 HYDRAULIC FEED CONTROL LEVER

25 . Personal Protective Equipment (PPE):

Each person must wear appropriate personal protective equipment whenever operating the chipper or working in the vicinity. This equipment is designed to prevent injury to any personnel in the area. This list includes but is not limited to:

- Safety shoes with slip resistant soles.
- Safety goggles or face shield.
- Hearing protection.
- Heavy or leather gloves.



Fig. 34 PERSONAL PROTECTIVE EQUIPMENT

26. Operating Hints:

- Keep the working area clean and free of debris to prevent slipping or tripping. Operate only on level ground.
- Do not place hands or any body parts into the feed hopper during operation. Use a stick or branch to push material into the rotor when it goes past the curtain in the feed hopper.
- Do not point discharge at people, animals or buildings. Rotor can expel wood chips fast enough to cause injury.



Fig. 35 WORKING

- Use care when feeding material into the chipper. Do not send metal, bottles, cans, rocks, glass or other foreign material into the wood chipper. If foreign material enters chipper, stop machine, turn engine off and place ignition key in your pocket and wait for all moving parts to stop before removing material and/or unplugging. Inspect machine for damaged or loose parts before resuming work.

5.9 TRANSPORTING



TRANSPORT SAFETY

1. Comply with state and local laws governing safety and transporting of machinery on public roads.
2. Check that all the lights, reflectors and other lighting requirements are installed and in good working condition.
3. Do not exceed a safe travel speed. Slow down for rough terrain and cornering.
4. Fold up and secure feed hopper before moving or transporting.
5. Be sure the trailer is hitched positively to the towing vehicle and a retainer is used through the mounting pins.
6. Do not drink and drive.
7. Be a safe and courteous driver. Always yield to oncoming traffic in all situations, including narrow bridges, intersections, etc. Watch for traffic when operating near or crossing roadways.
8. Never allow riders on the machine.

When transporting the machine, review and follow these instructions:

1. Clear the area of bystanders, especially small children.
2. Check that all the lights and reflectors required by the highway authorities are in place, clean and working.
3. Insure that the machine is securely attached to the tractor with a retainer through the mounting pins.
4. Do not allow riders.
5. Never exceed a safe travel speed. Slow down when encountering rough road conditions and cornering.
6. Do not drink and drive.
7. Raise and secure the feed hopper before transporting.
8. Turn the discharge hood and point toward the rotor to reduce the width of the machine.



Fig. 36 TRANSPORT CONFIGURATION

5. 10 STORAGE



OPERATING SAFETY

- Store the unit in an area away from human activity.
- Do not permit children to play on or around the stored machine.
- Store the unit in a dry, level area. Support the frame with planks if required.

5.10.1 PLACING IN STORAGE

After the season's use or when the machine will not be used for a period of time, completely inspect all major systems of the 3 Point Hitch Wood Chipper. Replace or repair any worn or damaged components to prevent any unnecessary down time at the beginning of the next season.

Follow this procedure before storing:

1. Remove all material from the machine.
2. Thoroughly wash the machine with a pressure washer or water hose to remove all dirt, mud or debris.

3. Inspect all rotating parts for entangled material. Remove all entangled material.
4. Run the machine a few minutes to dry the moisture from inside the machine.
5. Move the feed hopper up and lock.
6. Touch up all paint nicks and scratches to prevent rusting.
7. It is best to store the machine inside. If that is not possible, cover with a waterproof tarpaulin and tie down securely.
8. Store in an area away from human activity.
9. Do not allow children to play around the stored unit.

5.10.2 REMOVING FROM STORAGE

When removing this machine from storage, follow this procedure:

1. Remove the tarpaulin if covered.
2. Review and follow the pre-operation checklist.



Fig. 37 STORED

6 SERVICE AND MAINTENANCE



MAINTENANCE SAFETY

- Good maintenance is your responsibility. Poor maintenance is an invitation to trouble.
- Follow good shop practices.
 - Keep service area clean and dry.
 - Be sure electrical outlets and tools are properly grounded.
 - Use adequate light for the job at hand.
- Make sure there is plenty of ventilation. Never operate the engine of the towing vehicle in a closed building. The exhaust fumes may cause asphyxiation.
- Before working on this machine, shut off the engine, set the brake, and turn fuel valve off.
- Never work under equipment unless it is blocked securely.
- Always use personal protection devices such as eye, hand and hearing protectors, when performing any service or maintenance work. Use heavy gloves when handling sharp components.
- Where replacement parts are necessary for periodic maintenance and servicing, genuine factory replacement parts must be used to restore your equipment to original specifications. The manufacturer will not be responsible for injuries or damages caused by use of unapproved parts and/or accessories.
- A fire extinguisher and first aid kit should be kept readily accessible while performing maintenance on this equipment.
- Periodically tighten all bolts, nuts and screws and check that all electrical and fuel connections are properly secured to ensure unit is in a safe condition.
- When completing a maintenance or service function, make sure all safety shields and devices are installed before placing unit in service.

6.1 SERVICE

6.1.1 FLUIDS AND LUBRICANTS

1. **Grease:**
Use an SAE multipurpose high temperature grease with extreme pressure (EP) performance. Also acceptable is an SAE multipurpose lithium base grease.
2. **Storing Lubricants:**
Your machine can operate at top efficiency only if clean lubricants are used. Use clean containers to handle all lubricants. Store them in an area protected from dust, moisture and other contaminants.

6.1.2 GREASING

Use the Maintenance Checklist provided to keep a record of all scheduled maintenance.

1. Use a hand-held grease gun for all greasing.
2. Wipe grease fitting with a clean cloth before greasing, to avoid injecting dirt and grit.
3. Replace and repair broken fittings immediately.
4. If fittings will not take grease, remove and clean thoroughly. Also clean lubricant passageway. Replace fittings if necessary.

6.1.3 SERVICING INTERVALS

The period recommended is based on normal operating conditions. Severe or unusual conditions may require more frequent lubrication or oil changes.

Hours or Daily

1. Grease PTO driveline.

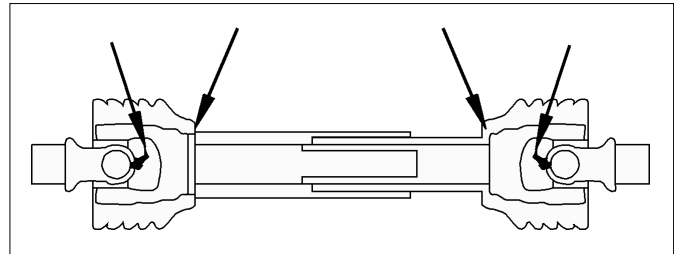

Fig. 38 PTO driveline

40 Hours or Weekly

1. Grease the telescoping section of the PTO shaft.



Fig. 39 TELESCOPING SECTION

2. Check input drive belt tensioner.

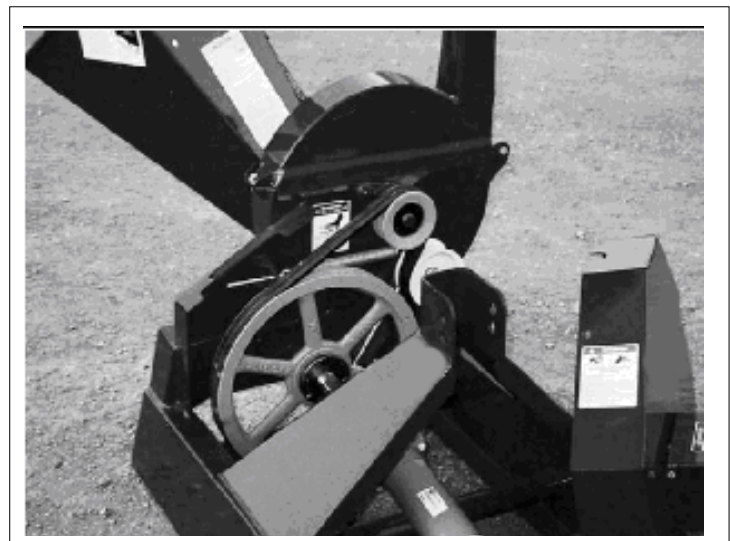
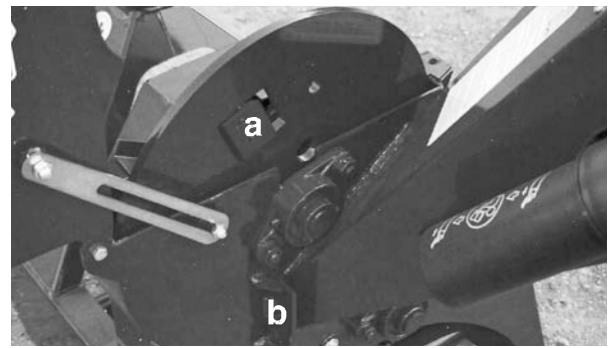

Fig. 40 BELT TENSION

3. Check sharpness of blades:

- a. Rotor
- b. Stationary

Remove, sharpen or switch edge as required.



BX32

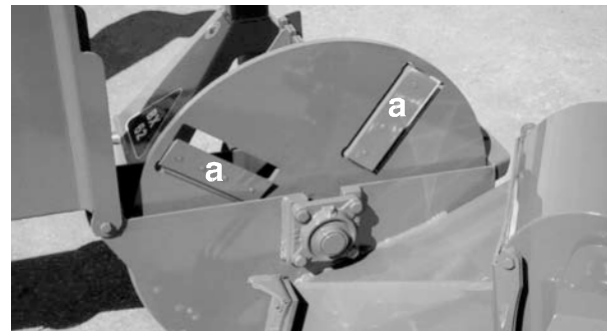

Rotor

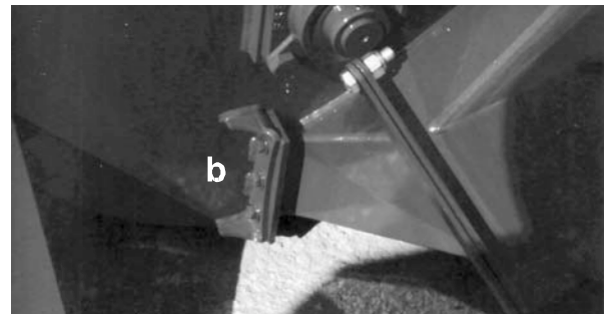

Stationary

Fig. 41 BLADES

100 Hours

1. Grease the hydraulic feed system:

- a. Roller bearings.
- b. Pivot bushing.

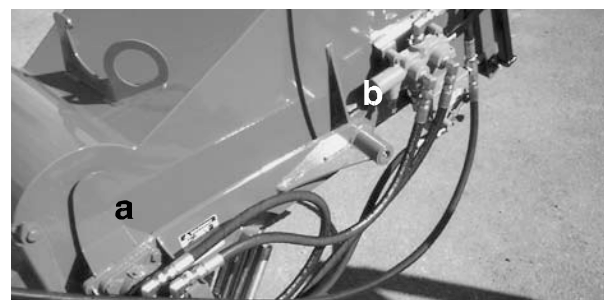

Left Side



Right Side

Fig. 42 HYDRAULIC FEED SYSTEM

100 Hours

2. Grease rotor bearings on BX42 and BX62 models.

IMPORTANT

Do not over grease.

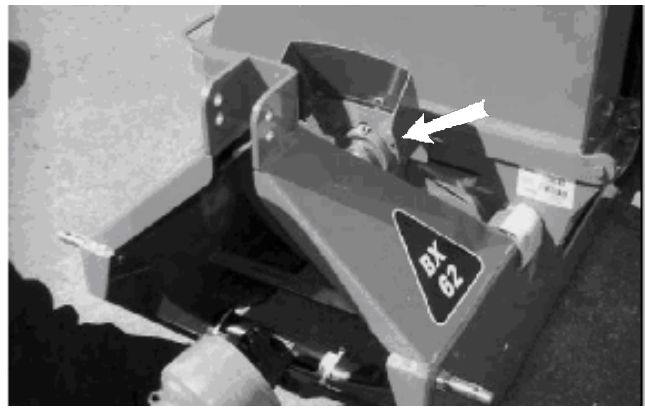

Front



Rear

Fig. 43 BEARINGS

3. Grease shaft bearings on BX32 model.
 - a. Rotor.
 - b. Jack shaft.

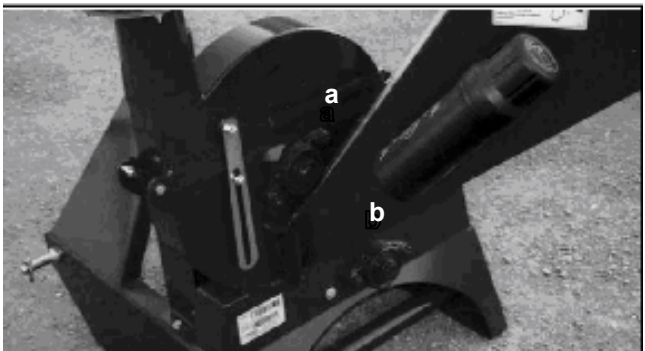

Front

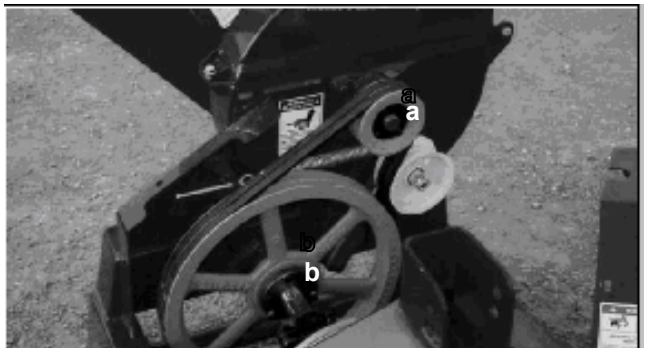

Rear

Fig. 44 BX32 BEARINGS

Annually

1. Clean machine.

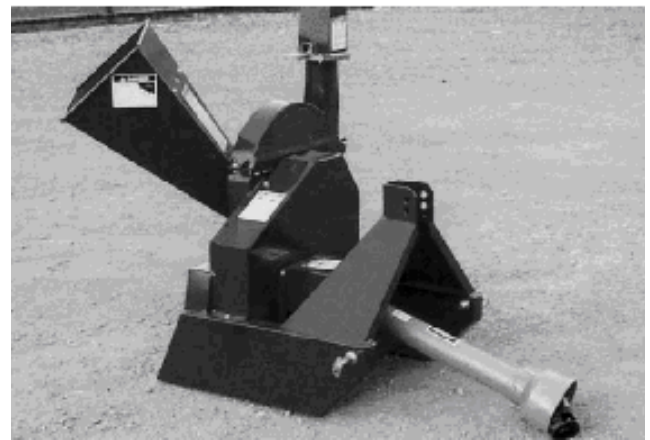

BX32



BX42

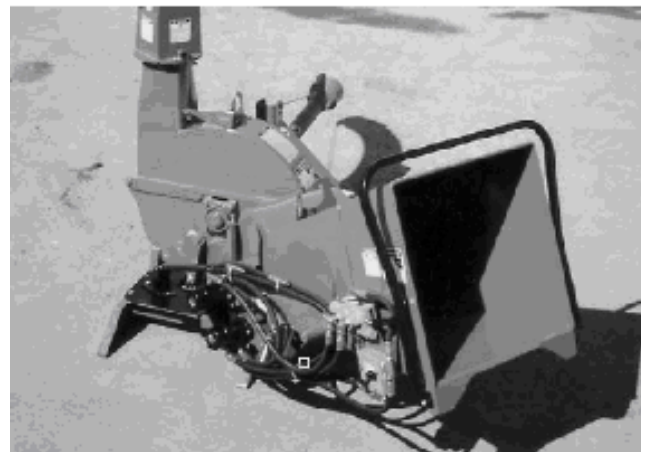

BX62

Fig. 45 MACHINE

6.2 MAINTENANCE

By following a careful service and maintenance program for your machine, you will enjoy many years or trouble-free operation.

6.2.1 DRIVELINE MAINTENANCE

The PTO driveline is designed to telescope to allow for dimensional changes as the machine goes through its operational range. A tubular guard encloses the driving components and is designed to turn relative to the driving components. The

1. Remove the driveline from the machine.
2. Pull driveline apart.
3. Use a screwdriver to turn lock studs on each end. There are 2 studs per guard.
4. Pull the shaft out of the plastic tubular guard.
5. Use a solvent to clean the male and female portions of the telescoping ends.
6. Apply a light coat of grease to each end.
7. Use a solvent to wash the grooves on each end where the studs are located. Clean each end also.
8. Apply a light coat of grease to each groove.
9. Insert the shaft into its respective guard and align the studs with the holes.
10. Insert the studs through the holes and seat in the groove.
11. Turn each stud to secure guard to shaft.
12. Check that each guard turns freely on the shaft.
13. Assemble the driveline.
14. Check that the driveline telescopes easily.
15. Replace any components that are damaged or worn.
16. Install the driveline on the machine.

driveline should telescope easily and the guard turn freely on the shaft at all times. Annual disassembly, cleaning and lubrication is recommended to insure that all components function as intended. To maintain the driveline, follow this procedure:



Guard Removal



Disassembled

Fig. 46 DRIVELINE COMPONENTS

6.2.2 DRIVE BELT TENSION AND ALIGNMENT (Model BX32)

A set of V belts transmits rotational power to the rotor. They must be kept properly tensioned and the pulleys aligned to obtain the expected performance and life.

To check the tension and alignment, follow this procedure:

1. Clear the area of bystanders, especially small children.
2. Turn machine off, stop engine, remove ignition key and place in pocket and wait for all moving parts to stop.
3. Remove guard over belt.
4. Push on the belt in the center of the span. The belt should deflect approximately 1 inch (25 mm) when pushed on with about 10 lbs. force to be properly tensioned.

IMPORTANT

The belt should not slip when the chipper is being used.

5. To adjust belt tension:

Use the adjusting bolt on the spring-loaded tensioning pulley to set the belt tension. The bolt should not slip when the machine is being used with a normal load.

6. To replace belt:

- a. Move idler pulley to its loosest position.
 - b. Replace belt.
 - c. Set pulley alignment.
 - d. Move idler pulley to set the belt tension.
 - e. Check frequently during the first 10 hours and set belt tension as required.
7. Lay a straight edge across the pulley faces to check the alignment. Adjust alignment if pulley faces vary more than 1/32 inch (.7 mm).



Adjusting Bolt

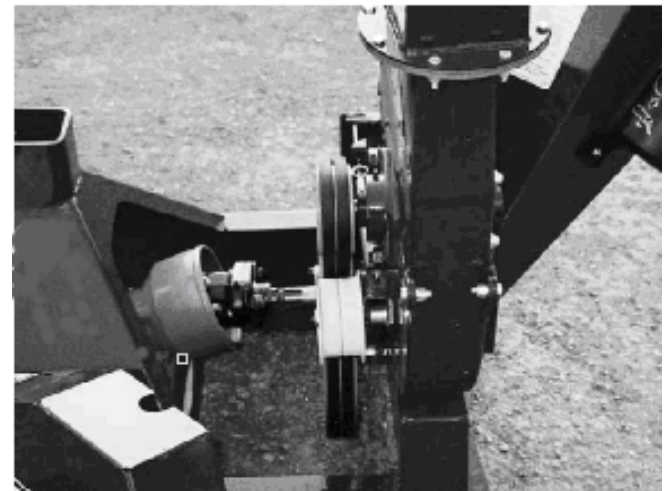

Alignment

Fig. 47 BELT DRIVE SYSTEM



7 SPECIFICATIONS

7.1 BOLT TORQUE

CHECKING BOLT TORQUE

The tables shown below give correct torque values for various bolts and cap screws. Tighten all bolts to the torques specified in chart unless otherwise noted. Check tightness of bolts periodically, using bolt torque chart as a guide. Replace hardware with the same strength bolt.

ENGLISH TORQUE SPECIFICATIONS

Bolt Diameter "A"	Bolt Torque*					
	SAE 2 (N.m) (lb-ft)		SAE (N.m) (lb-ft)		SAE (N.m) (lb-ft)	
1/4"	8	6	12	9	17	12
5/16"	13	10	25	19	36	27
3/8"	27	20	45	33	63	45
7/16"	41	30	72	53	100	75
1/2"	61	45	110	80	155	115
9/16"	95	60	155	115	220	165
5/8"	128	95	215	160	305	220
3/4"	225	165	390	290	540	400
7/8"	230	170	570	420	880	650
1"	345	225	850	630	1320	970

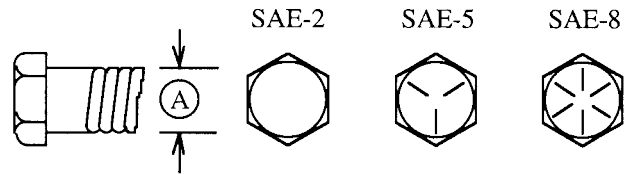

METRIC TORQUE SPECIFICATIONS

Bolt Diameter "A"	Bolt Torque*			
	0.8 (N.m) (lb-ft)		0.9 (N.m) (lb-ft)	
M3	.5	.4	1.8	1.3
M4	3	2.2	4.5	3.3
M5	6	4	9	7
M6	10	7	15	11
M8	25	18	35	26
M10	50	37	70	52
M12	90	66	125	92
M14	140	103	200	148
M16	225	166	310	229
M20	435	321	610	450
M24	750	553	1050	774
M30	1495	1103	2100	1550
M36	2600	1917	3675	2710

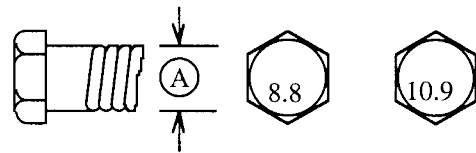

Torque figures indicated above are valid for non-greased or non-oiled threads and heads unless otherwise specified. Therefore, do not grease or oil bolts or cap screws unless otherwise specified in this manual. When using locking elements, increase torque values by 5%.

* Torque value for bolts and cap screws are identified by their head markings.

7.2 HYDRAULIC FITTING TORQUE

Tightening Flare Type Tube Fittings *

1. Check flare and flare seat for defects that might cause leakage.
2. Align tube with fitting before tightening.
3. Lubricate connection and hand tighten swivel nut until snug.
4. To prevent twisting the tube(s), use two wrenches. Place one wrench on the connector body and with the second tighten the swivel nut to the torque shown.
5. The torque values shown are based on lubricated connections.

Tube Size OD (in.)	Nut Size Across Flats (in.)	Torque Value•		Recommended Turns To Tighten (After Finger Tightening)	
		(N.m)	(lb-ft)	(Flats)	(Turn)
3/16	7/16	8	6	1	1/6
1/4	9/16	12	9	1	1/6
5/16	5/8	16	12	1	1/6
3/8	1 1/8	24			1/6
1/2	7/8	46	34	1	1/6
5/8	1	62	46	1	1/6
3/4	1-1/4	102	75	3/4	1/8
7/8	1-3/8	122	90	3/4	1/8